



**DE** Gebrauchsanleitung  
**EN** Instruction manual  
**FR** Manuel d'utilisation  
**NL** Gebruiksaanwijzing  
**IT** Istruzioni per l'uso  
**ES** Manual de instrucciones  
**PT** Manual de utilização  
**NO** Bruksanvisning  
**SV** Bruksanvisning  
**FI** Käyttöopas  
**DA** Betjeningsvejledning  
**PL** Instrukcja obsługi  
**SL** Navodila za uporabo  
**SK** Návod na obsluhu  
**HU** Használati útmutató  
**SR** Uputstvo za upotrebu  
**HR** Upute za uporabu  
**CS** Návod k použití  
**LV** Lietošanas pamācība

**LT** Naudojimo instrukcija  
**RO** Instrucțiuni de utilizare  
**EL** Οδηγίες χρήσης  
**RU** Инструкция по эксплуатации  
**BG** Инструкция за експлоатация  
**UK** Посібник з експлуатації  
**ET** Kasutusjuhend  
**KK** Пайдаланушының нұсқаулығы

GHE 105.0





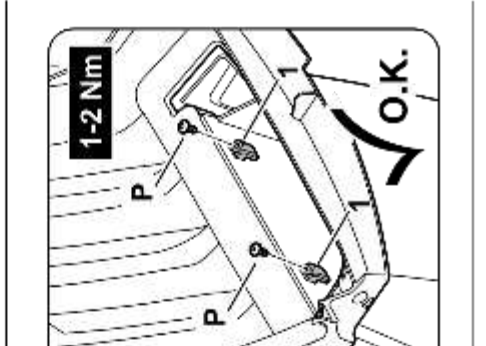
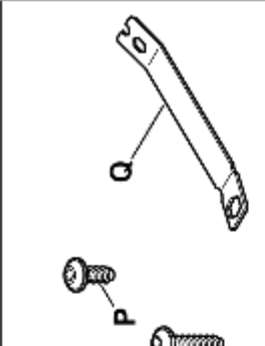
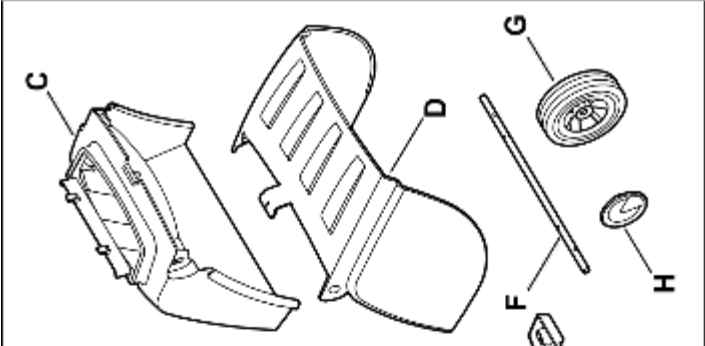

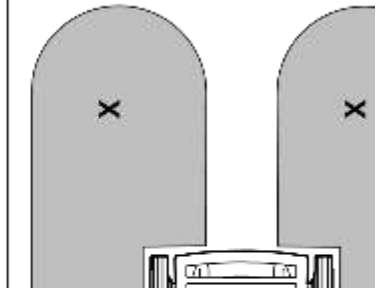
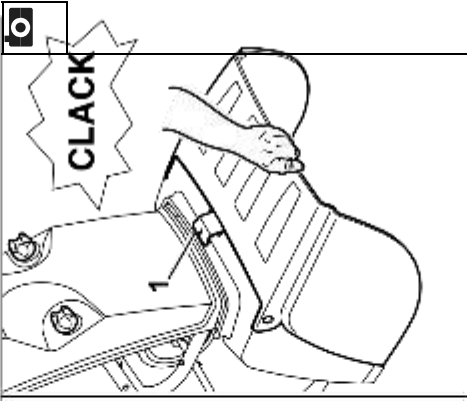
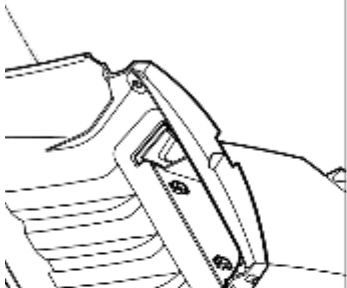

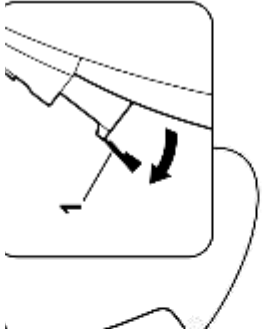

o.k.

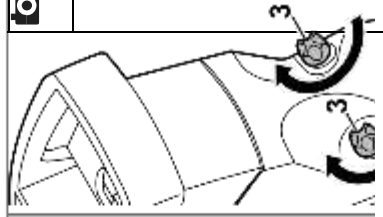
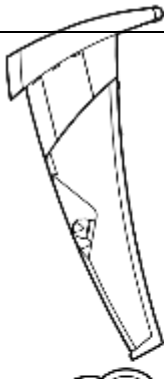

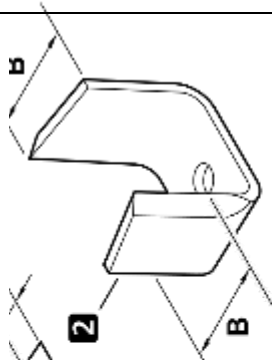

**B > 18mm**

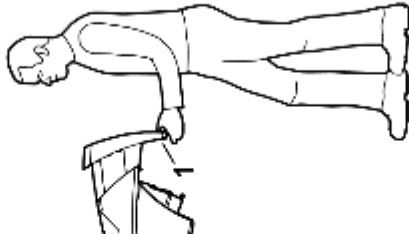

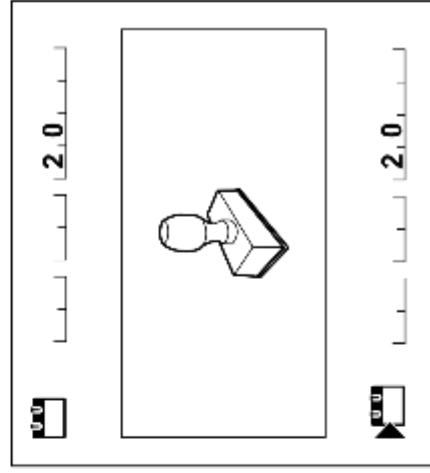
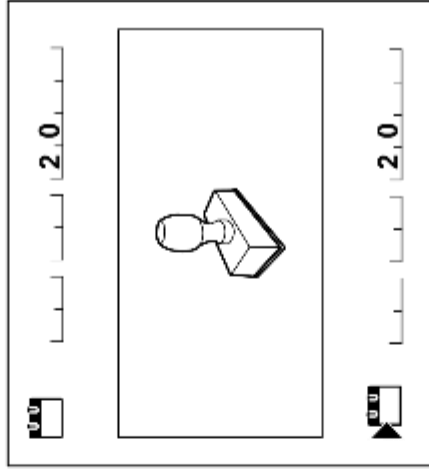
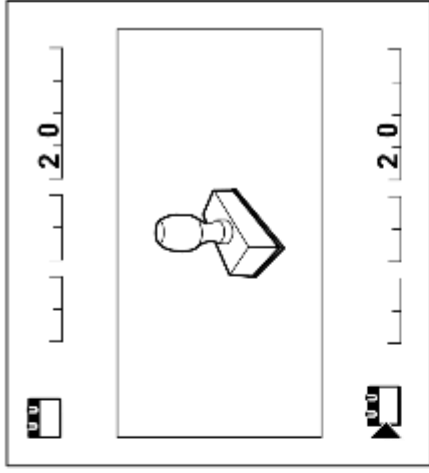
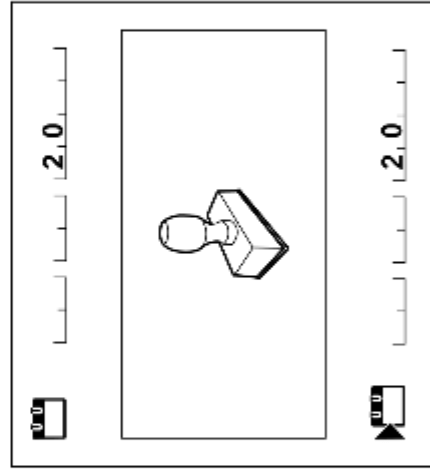
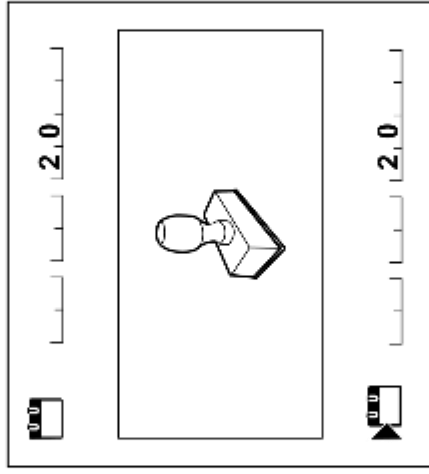
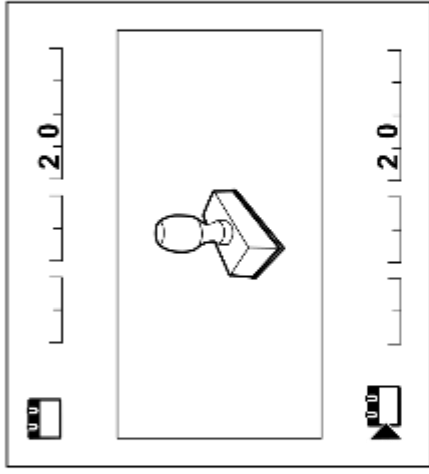
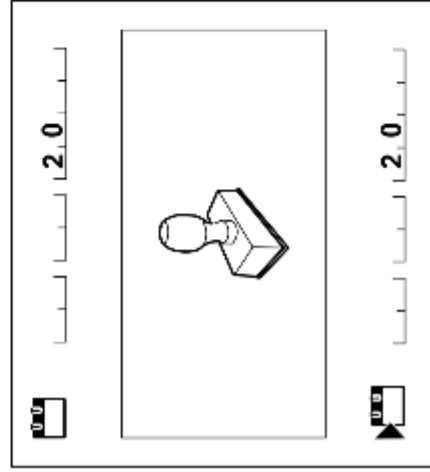
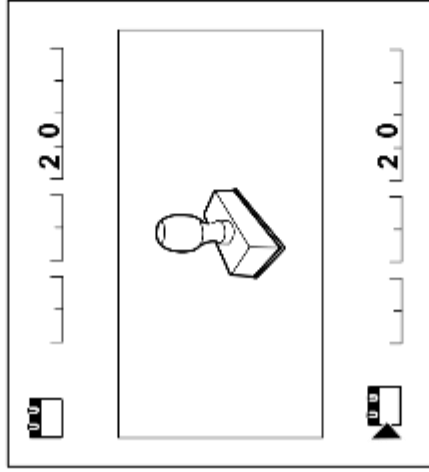
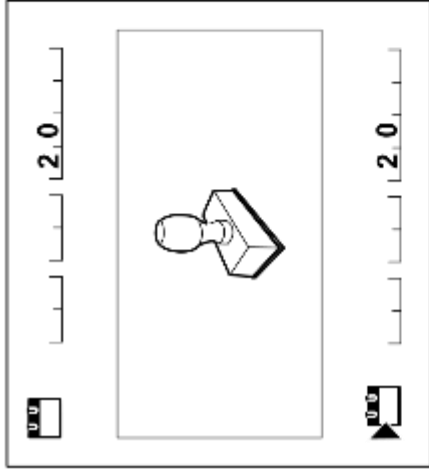

## Dear Customer,

Thank you for choosing STIHL. We develop and manufacture our quality products to meet our customers' requirements. The products are designed for reliability even under extreme conditions.

STIHL also stands for premium service quality. Our specialist dealers guarantee competent advice and instruction as well as comprehensive service support.

We thank you for your confidence in us and hope you will enjoy working with your STIHL product.



Dr. Nikolas Stihl

**IMPORTANT: READ BEFORE USE AND KEEP IN A SAFE PLACE.**

## 1. Table of contents

<b>Notes on the instruction manual</b>	<b>28</b>		
General	28	Working area for operator	36
Instructions for reading the instruction manual	28	Correct machine load	36
Country-specific versions	28	Overload protection	37
<b>Machine overview</b>	<b>29</b>	If the cutting unit of the garden shredder is blocked	37
<b>For your safety</b>	<b>29</b>	Correct way to feed the garden shredder	37
General	29	<b>Safety devices</b>	
Warning – dangers caused by electrical current	30	Motor restart inhibitor	37
Clothing and equipment	30	Safety interlock	37
Transporting the machine	31	Motor run-down brake	37
Before operation	31	Protective covers	37
During operation	32	<b>Operating the machine</b>	<b>37</b>
Maintenance and repairs	33	Electrical connection of garden shredders	38
Storage for prolonged periods without operation	34	Connecting the power cable	38
Disposal	34	Switching on the garden shredder	38
<b>Description of symbols</b>	<b>34</b>	Switching off the garden shredder	38
<b>Standard equipment</b>	<b>35</b>	Shredding	38
<b>Preparing the machine for operation</b>	<b>35</b>	<b>Maintenance</b>	<b>38</b>
Attaching wheel axle and wheels	35	Cleaning the machine	39
Installing the ejection chute extension and chassis	35	Removing the feed chute	39
Installing the discharge flap	36	Installing the feed chute	39
Opening and closing the discharge flap	36	Locking the blade disc	39
Tool box	36	Knife maintenance	39
<b>Notes on working with the machine</b>	<b>36</b>	Electric motor and wheels	40
What material can be processed?	36	Storage and winter break	40
What material cannot be processed?	36	<b>Transport</b>	<b>41</b>
Maximum branch diameter	36	Lifting or carrying the garden shredder	41
		Pulling or pushing the garden shredder	41
		Transporting the garden shredder on a load floor	41
		<b>Minimising wear and preventing damage</b>	<b>41</b>
		<b>Standard spare parts</b>	<b>42</b>
		<b>Environmental protection</b>	<b>42</b>



<b>Declaration of conformity</b>	<b>42</b>
EU declaration of conformity –	
STIHL GHE 105.0 garden shredder	<b>42</b>
UKCA-Declaration of Conformity	
STIHL GHE 105.0	<b>42</b>
Garden Shredder	<b>43</b>
<b>Technical specifications</b>	<b>43</b>
REACH	<b>44</b>
<b>Troubleshooting</b>	<b>44</b>
<b>Service schedule</b>	<b>44</b>
Handover confirmation	<b>44</b>
Service confirmation	<b>44</b>

## 2. Notes on the instruction manual

### 2.1 General

This instruction manual is a **translation of the original manufacturer's instructions** in the sense of EC Directive 2006/42/EC.

STIHL is continually striving to further develop its range of products; we therefore reserve the right to make alterations to the form, technical specifications and equipment level of our standard equipment.

For this reason, the information and illustrations in this manual are subject to alterations.

This instruction manual may describe models that are not available in all countries.

This instruction manual is protected by copyright. All rights reserved, especially the right of reproduction, translation and processing using electronic systems.

### 2.2 Instructions for reading the instruction manual

Illustrations and texts describe specific operating steps.

All symbols which are affixed to the machine are explained in this instruction manual.

#### Viewing direction:

Viewing direction when **left and right** are used in the instruction manual: the user is standing behind the machine (working position).

#### Section reference:

References to relevant sections and subsections for further descriptions are made using arrows. The following example shows a reference to a section: (⇒ 3.)

#### Designation of text passages:

The instructions described can be identified as in the following examples.

Operating steps which require intervention on the part of the user:

- Release screw (1) using a screwdriver, operate lever (2)...

General lists:

- Use of the product for sporting or competitive events

#### Texts with added significance:

Text passages with added significance are identified using the symbols described below in order to especially emphasise them in the instruction manual:



#### Danger

Risk of accident and severe injury to persons. A certain type of behaviour is necessary or must be avoided.



#### Warning

Risk of injury to persons. A certain type of behaviour prevents possible or probable injuries.



#### Caution

Minor injuries or material damage can be prevented by a certain type of behaviour.



#### Note

Information for better use of the machine and in order to avoid possible operating errors.

#### Texts relating to illustrations:

Illustrations relating to use of the machine can be found in the front of this instruction manual.



The camera symbol serves to link

the figures on the illustration pages with the corresponding text passages in the instruction manual.

### 2.3 Country-specific versions

STIHL supplies machines with different plugs and switches, depending on the country of sale.

Machines with European plugs are shown in the illustrations. Machines with other types of plug are connected to the mains in a similar way.

### 3. Machine overview



- 1 Chute
- 2 Closure screws
- 3 Discharge flap
- 4 Wheel carrier
- 5 Basic unit
- 6 Handle
- 7 On/off switch with mains connection
- 8 Rating plate with machine number
- 9 Tool box

### 4. For your safety

#### 4.1 General

 These safety regulations must be observed when working with the machine.

 Read the entire instruction manual before using the machine for the first time. Keep the instruction manual in a safe place for future reference.

These safety precautions are essential for your safety, however the list is not exhaustive. Always use the machine in a reasonable and responsible manner and be aware that the user is responsible for accidents involving third parties or their property.

#### Risk of injury!

Uninstructed users cannot recognise or evaluate the dangers posed by the garden shredder. This may result in serious or fatal injury to the user or other people.

Make sure that you are familiar with the controls and use of the machine.

The machine must only be used by persons who have read the instruction manual and are familiar with operation of the machine. The user should seek expert and practical instruction prior to initial operation. The user should receive instruction on safe use of the machine from the vendor or another expert.

During this instruction, the user should be made aware that the utmost care and concentration are required for working with the machine.

Residual risks persist even if you operate this machine according to the instructions.

#### Risk of death from suffocation!

Packaging material is not a toy - danger of suffocation! Keep packaging material away from children.

Only give or lend the machine, including any accessories, to persons who are familiar with this model and how to operate it. The instruction manual forms part of the machine and must always be provided to persons borrowing it.

Make sure that the user is physically, sensorily and mentally capable of operating the machine and working with it. If the user is physically, sensorily or mentally impaired, the machine must only be used under supervision or following instruction by a responsible person.

Make sure that the user is of legal age or being trained under supervision in a profession in accordance with national regulations.

The machine must only be operated by persons who are well rested and in good physical and mental condition. If your health is impaired, you should consult your doctor to determine whether working with the machine is possible. The machine should not be operated after the consumption of alcohol, drugs or medications which impair reactions.

The machine is intended for private use.

#### Caution – risk of accident!

 STIHL garden shredders are suitable for shredding branch material and plant trimmings. Their use for other purposes is not permitted and may be dangerous or result in damage to the machine.

The garden shredder must not be used (incomplete list):

- for any other materials (e.g. glass, metal),
- for tasks other than those described in this instruction manual.
- for the preparation of foodstuffs (e.g. crushing ice, mashing pulp).

For safety reasons, any modification to the machine, except the proper installation of accessories approved by STIHL, is forbidden and results in voiding of the warranty cover. Information regarding approved accessories can be obtained from your STIHL specialist dealer.

In particular, any tampering with the machine which increases the power output or speed of the engine or motor is forbidden.

It is not permitted to transport objects, animals or persons, particularly children, on the machine.

Particular care is required during use in public green spaces, parks, sports fields, along roads and in agricultural and forestry businesses.

Only release the machine if it is on a level surface and cannot roll away by itself.

#### 4.2 Warning – dangers caused by electrical current



##### Warning:

##### Risk of electric shock!

Particularly important for electrical safety are the power cable, mains plug, On / Off switch and electric cable. Damaged cables, connectors and plugs, or electric cables that do not conform to regulations must not be used, to prevent any risk of electric shocks. Therefore, check the electric cable regularly for signs of damage or ageing (brittleness).



Only operate machine with fully uncoiled power cable.

Extension reels must always be fully unwound before use.

Never use a damaged extension cable. Replace defective cables with new ones and never repair extension cables.

If the power cable or extension cable is damaged during operation, immediately disconnect the power cable or extension cable from the power supply. Never touch the damaged power cable or extension cable.

Never use the machine if the cables are damaged or worn. Check the power cable in particular for damage and ageing.

Maintenance and repair work on power cables must only be performed by specially qualified technicians.



##### Risk of electric shock!

Do not connect a damaged cable to the mains and only touch a damaged cable once it has been disconnected from the mains.

Only touch the cutting units (blades) when the machine is disconnected from the mains.

Always ensure that the power cables used are adequately protected by a fuse.



Do not work in the rain or in a wet environment.

Only use extension cables that are insulated against moisture for outdoor use which are suitable for use with the machine (⇒ 10.1).

Detach electric cables at the plug and socket and not by pulling on the electric cable.

Do not leave the machine unprotected in the rain.

It must be noted that current fluctuations can damage the machine when it is connected to a power generator.

Only connect the machine to a power supply that is protected by means of a residual current-operated protective device with a release current of a maximum of 30 mA. Your electrician can provide further information.

#### 4.3 Clothing and equipment



Always wear sturdy footwear with high-grip soles when working. Never work barefoot or, for example, in sandals.



Always wear close-fitting protective gloves made of a puncture- and cut-resistant material with a closed cuff to protect against mechanical risks such as punctures and cuts during work, maintenance work, when transporting the chipper and when rectifying faults. This reduces the risk of hand injuries when inserting long or multi-piece branches and during maintenance. Suitable protective gloves are tested in accordance with standard EN 388 or national regulations and are commercially available with the appropriate labelling.



Always wear close-fitting safety glasses when working.



Suitable safety glasses are tested for mechanical strength in accordance with EN 166 or national regulations and are commercially available with the corresponding marking.



Always wear hearing protection when working.



Suitable hearing protection is tested in accordance with EN 352 or national regulations and available commercially with the corresponding marking.

Wear both at all times.



Wear suitable, close-fitting clothing when working with the machine, e.g. overalls, but not work coats. Do not wear scarves, ties, jewellery, clothing with dangling straps or cords or other protruding articles of clothing when working with the machine.

Long hair must be tied up and secured (headscarf, cap, etc.) at all times when operating or performing work on the machine.

#### 4.4 Transporting the machine

Always wear protective gloves (⇒ 4.3) in order to prevent injuries due to sharp-edged and hot components.

Do not transport the machine with the motor running. Switch off the motor, allow the blades to come to a standstill and disconnect the mains plug prior to transport.

Only transport the machine once the motor has cooled down.

Only transport the machine with the feed chute properly fitted.

#### Risk of injury!

The user may injure themselves on exposed blades.

Pay particular attention to the weight of the machine, especially when tilting.

Use suitable loading aids (loading ramps, lifters).

Secure the machine on the load floor using adequately dimensioned fastening material (straps, ropes etc.) at the fastening points described in this instruction manual. (⇒ 12.3)

Push or pull the machine at walking pace only. Do not tow!

When transporting the machine, always observe regional legislation, especially regarding load security and the transport of objects on load floors.

#### 4.5 Before operation

Make sure that only persons who are familiar with the instruction manual are permitted to use the machine.

Remove the packaging material and transport locks before using the machine for the first time.

Observe the local regulations regarding permitted operating times for gardening power tools with combustion engines or electric motors.

All faulty, worn or damaged parts must be replaced before using the machine. Replace any illegible or damaged danger signs and warnings on the machine. Your STIHL specialist has a supply of replacement stickers and all the other spare parts.

#### Risk of injury!

Worn or damaged parts (e.g. blunt blades) can affect the safety of the machine and result in injury to the user.

Before initial operation, check and ensure the following:

- The machine is in good operational condition. This means that the covers and guards must be in place and in good condition.
- A properly installed socket is used for the electrical connection.

- The insulation of the electric cable, extension cable, plug and connector is in good condition.

- The complete machine (motor housing, guards, fastening elements, blades, blade shaft, blade discs, etc.) is neither worn nor damaged.

- There is no shredding material in the machine and the feed chute is empty.

- All screws, bolts, nuts and other fastening elements are in place and properly tightened. Tighten any loose screws, bolts and nuts prior to initial operation (observe tightening torque).

Only use the machine out-of-doors and not close to walls or any other solid objects in order to prevent the risk of injuries and property damage (no escape for the user, broken windows, scratched cars etc.).

The machine must be placed in a stable position on firm and level ground.

Do not use the machine on a paved or gravel-covered surfaces, as ejected or thrown-up material could cause injuries.

Before using the machine, always check that it is properly closed. (⇒ 11.3)

Make sure that you are familiar with the On / Off switch so that you can react quickly and correctly in any emergency situation.

The splash guard in the feed chute must cover the feed opening and must be undamaged – replace the splash guard if damaged.

DE

EN

FR

NL

IT

ES

PT

NO

SV

FI

DA

PL

SL

SK

HU



### Risk of injury!

Only operate the machine when properly assembled. If parts are missing from the machine (e.g. wheels), the prescribed safety distances are no longer maintained and the machine may also have reduced stability.

**The machine must be visually inspected to ensure that it is in proper condition before it is put into operation!**

"Good operating condition" means that the machine is fully assembled, in particular:

- Upper chute is installed on lower chute
  - Splash guard and chute insert with STIHL cloverleaf opening is correctly installed in upper chute
  - Feed chute is installed on basic unit and both closure screws are fastened hand-tight
  - Wheel carrier assembly is installed
  - Both wheels are mounted
  - All safety devices (ejection chute, splash guard, etc.) must be present and functional
  - Cutting unit (blade disc) is installed
  - All blades are properly installed.
- The switch and safety devices installed in the machine must not be removed or bypassed.

Visually inspect the blade disc for damage and deformation; replace if necessary.

### 4.6 During operation



Never work when animals or people, particularly children, are in the danger area.

Do not operate the machine in the rain or during thunder storms, particularly when there is a risk of lightning strike.

The risk of accidents is higher if the ground is damp due to increased danger of slipping.

Particular caution should be exercised during working in order to prevent slipping. If possible, avoid using the machine when the ground is damp.

Only work during the day or with good artificial light.

Keep the working area neat and tidy at all times. Remove tripping hazards such as stones, branches, cables etc.

The operator should not stand any higher than the level of the base of the machine.

### Starting:

Place the machine in a stable and upright position prior to starting. The machine must never be operated in a horizontal position.

Exercise care when switching on the machine and observe the instructions in the section "Operating the machine". (⇒ 10.3)

Do not stand in front of the discharge opening when starting the engine or switching on the motor. There must be no shredding material in the garden shredder when it is started or switched on. Shredding material may be ejected and lead to injuries.

The machine must not be tilted during start-up.

Avoid switching the machine on repeatedly within a short period of time; particularly avoid "playing" with the On / Off switch. Risk of motor overheating.

Owing to the voltage fluctuations caused by this machine during the start-up, other devices connected to the same circuit may be subject to interference in the case of unfavourable power supply conditions.

In this case, appropriate steps should be taken (e.g. connection to a different circuit than the one used by the affected device, or operation of the machine using a circuit with a lower impedance).

### Working:



### Risk of injury!

Never place your hands or feet above, underneath or on rotating parts.

When the machine is running, never put your face or any other part of your body above the feed chute or in front of the ejection opening. Always keep your head and body away from the feed opening.



Never put your hands or any other part of your body or clothing into the feed chute or ejection chute. There is a considerable risk of injury to eyes, face, fingers, hands etc.

Always maintain your balance and firm footing. Do not stretch forward.

The splash guard must not be tampered with (removed, folded up, jammed into position, damaged etc.) during operation.

The operator must stand in the working area described when feeding the shredder. Stay inside the working area and outside of the ejection zone at all times during operation of the machine. (⇒ 8.4)



#### **Risk of injury!**

Shredding material may be ejected back up during operation. This may result in serious injury to the user's face, eyes and hands. Therefore wear safety glasses and protective gloves (⇒ 4.3) and keep your head away from the feed opening.

Never tilt the machine when the engine or motor is running.

If the machine falls over during operation, immediately switch off the motor and disconnect the mains plug.

Make sure that there is no shredding material blocking the ejection chute, as this could result in poor shredding performance or kickbacks.

When feeding the garden shredder, pay particular attention to ensuring that no foreign objects such as bits of metal, stones, plastic, glass, etc. get into the shredding chamber as this could result in damage or kickbacks from the feed chute.



#### **Risk of injury!**

Shredding material kickback and foreign objects may result in severe injury to the user. Keep foreign objects away from the machine and remove blockages immediately.



#### **Risk of injury!**

Kickbacks can occur when feeding the garden shredder with branch material. Shredding material kickback may result in serious injury to the user. Wear protective gloves and safety glasses (⇒ 4.3).



**STOP**

Beware of the cutting tool running on for several seconds before coming to a standstill.

Switch off the motor, disconnect the mains plug and allow all rotating tools to reach a complete standstill

- before leaving the machine unattended
- before repositioning, lifting, carrying, tilting, pushing or pulling the machine
- before unscrewing the closure screws and opening the machine
- before transporting the machine
- before removing blockages at the cutting unit, in the feed chute or in the discharge chute
- before carrying out any work on the blade disc
- before checking or cleaning the machine or before carrying out any other work on it.

If foreign objects get into the cutting tool or if the machine makes unusual noises or vibrates in an unusual way, switch off the motor immediately and allow the machine to come to rest. Detach the mains plug, remove the feed chute and perform the following steps:

- Check the machine, in particular the cutting unit (blades, blade disc, blade mounting, blade fastening screw, clamping ring) for damage or wear and have any necessary repairs and maintenance operations carried out by a technician before starting again and working with the machine.
- Check that all parts of the cutting unit are seated securely, retighten the screws if necessary (observe tightening torques).
- Have damaged or worn parts replaced or repaired by a specialist; the parts must be of similar quality.

#### **4.7 Maintenance and repairs**



Before carrying out any maintenance operations (cleaning, repair, etc.) and before checking whether the electric cable is entwined or damaged, park the machine on firm, level ground, switch off the motor and disconnect the mains plug.

Leave the machine to cool down for approx. 5 minutes before performing any maintenance operations.

Before performing maintenance of the cutting tool, ensure that the cutting tool can still be turned despite the locking device, even when the power supply is switched off.

The power cable must only be repaired or replaced by authorised electricians.

#### **Cleaning:**

The complete machine must be cleaned thoroughly following use. (⇒ 11.1)

Never use high-pressure cleaners and do not clean the machine under running water (e.g. using a garden hose).

Do not use aggressive cleaning agents. These can damage plastics and metals, impairing the safe operation of your STIHL machine.

#### **Maintenance operations:**

Only maintenance operations described in this instruction manual may be carried out. Have all other work performed by a specialist dealer.

If you do not have the necessary expertise or auxiliary equipment, please **always** contact a specialist dealer. STIHL recommends that you have maintenance operations and repairs

performed exclusively by a STIHL specialist dealer. STIHL specialist dealers regularly attend training courses and are provided with technical information.

Only use tools, accessories or attachments approved for this machine by STIHL or technically identical parts. Otherwise, there may be a risk of accidents resulting in personal injury or damage to the machine. If you have any questions, please consult a specialist dealer.

The characteristics of original STIHL tools, accessories and spare parts are optimally adapted to the machine and the user's requirements. Genuine STIHL spare parts can be recognised by the STIHL spare parts number, by the STIHL lettering and, if present, by the STIHL spare parts symbol. On smaller parts, only the symbol may be present.

Always keep warning and information stickers clean and readable. Damaged or missing stickers must be replaced by new, original plates from your STIHL specialist dealer. If a component is replaced with a new component, ensure that the new component is provided with the same stickers.

Only perform work on the cutting unit when wearing protective gloves (⇒ 4.3) and exercising extreme care.

Ensure that all nuts, pins and screws, especially all the cutting unit screws, are securely tightened, so that the machine is in a safe operating condition.

Check the entire machine for wear or damage on a regular basis, particularly before extended periods when the machine is not in use (e.g. over winter). For safety reasons, worn or damaged

parts must be replaced immediately to ensure that the machine is always in a safe operating condition.

Components or guards that are removed for maintenance operations must be properly reinstalled immediately.

#### 4.8 Storage for prolonged periods without operation

Allow the machine to cool for approx. 5 minutes before storing it in an enclosed space.

Ensure that the machine is protected from unauthorised use (e.g. by children).

Thoroughly clean the machine before storage (e.g. winter break).

Store the machine in good operational condition.

Store the machine on a level surface so that it cannot unintentionally roll away.

#### Risk of injury from exposed blades!

Only store garden shredders with the feed chute fitted.

#### 4.9 Disposal

Waste products can be harmful to people, animals and the environment. They must consequently be disposed of properly.

Consult your recycling centre or your specialist dealer for information on the proper disposal of waste products. STIHL recommends STIHL specialist dealers.

Ensure that old machines are properly disposed of. Render the machine unusable prior to disposal. In order to

prevent accidents, always remove the power cable and electric cable to the motor.

## 5. Description of symbols



### Caution!

Read the instruction manual before initial use.



### Risk of injury!

Keep other people out of the danger area.



### Risk of injury!

Rotating tools!  
Keep hands and feet away from apertures when the machine is running.

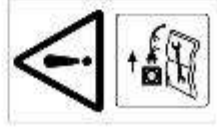

### Risk of injury!

Switch off the motor and disconnect the power cable from the machine before working on the cutting tool, before performing maintenance and cleaning work, before checking whether the electric cable is entwined or damaged and before leaving the machine unattended.

**Risk of injury!**

Rebounding branches and shredding material can pierce hands or fingers.



Wear hearing protection and safety glasses (⇒ 4.3).



Wear protective gloves (⇒ 4.3).



Feed the hard material into the feed chute diagonally from the top left to the bottom right towards the blade unit.



Do not work in the rain or in a wet environment.

**Risk of injury!**

Cutting tool runs on. Wait until the cutting tool has come to a standstill.

**Risk of injury:**

Do not climb onto the machine.

**Risk of injury:**

Never put your hands or any other part of your body or clothing into the feed chute or ejection chute.

**Risk of injury!**

Never insert hard material other than as described.

**Risk of injury!**

Feed the hard material into the feed chute diagonally from the top left to the bottom right towards the blade unit. Never insert hard material into the marked area.



Tool box

**6. Standard equipment**

Item	Designation	Qty.
A	Basic unit with feed chute	1
B	Wheel carrier	1
C	Ejection chute extension	1
D	Discharge flap	1
E	Strip	1
F	Wheel axle	1
G	Wheel	2
H	Wheel cap	2
I	Pin	2
J	Hexagon bolt M5x40	2
K	Nut M5	2
L	Washer A13	2
M	Quick fastener	2
N	Self-tapping screw P5 x 40	2
O	Torx screw P5 x 20	3
P	Torx screw P5 x 10	2
Q	Combination spanner	1
	Instruction manual	1

**7. Preparing the machine for operation****Risk of injury:**

Observe the safety instructions in the "For your safety" section. (⇒ 4.)

**7.1 Attaching wheel axle and wheels**

- Attach the wheel axle (F) to the wheel carrier (B) with the bolts (J) and nuts (K) using the combination spanner (Q) (4 - 6 Nm).
- Push the washers (L) and wheels (G) onto the mounted wheel axle.
- Attach the wheels to the wheel axle using quick fasteners (M). Quick fasteners must be pushed onto the wheel axle only to the extent that the wheels can still turn freely once mounted.
- Press on the wheel caps (H).

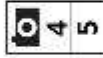

Quick fasteners (M) can only be detached by destroying.

**7.2 Installing the ejection chute extension and chassis**

- Place basic unit (A) with the chute facing downwards onto a level, clean surface.
- Engage the hooks (1) of the ejection chute extension (C) into the openings (A) on the rear of the basic unit and tilt the extension so that the front part of the basic unit is precisely inserted in the opening of the ejection chute extension.



- Install the screws (P) in the hooks (1) as shown (1 - 2 Nm).
- Push the chassis with both wheel carriers (2) up to the stop in the guides on the basic unit (A).
- Push the wheel carrier (3) into the recess on the ejection chute extension.
- Fasten the chassis with bolts (N) (1 - 2 Nm).

### 7.3 Installing the discharge flap



- Insert strip (E) into ejection chute extension. Install screws (O) (1 - 2 Nm).
- Lift garden shredder into upright position.
- Position discharge flap (D) on ejection chute extension. Ensure that the ribs (1) inside the flaps on the left and right are correctly located in the guide groove of the ejection chute extension (2) when attaching.
- Press in pins (I) on left and right.

### 7.4 Opening and closing the discharge flap



#### Opening the discharge flap:

- For shredding, fold the discharge flap (D) upwards and allow the tab (1) to engage in the ejection chute extension.

#### Closing the discharge flap:

- For transport or space-saving storage, lift the tab (1) slightly and fold away the discharge flap (D) downwards.

### 7.5 Tool box



- The combination spanner (Q) can be inserted from below into the tool box (2) in the rear section of the chute (1).

## 8. Notes on working with the machine

### 8.3 Maximum branch diameter

Maximum branch diameter:  
**35 mm**



When inserting several thin branches at the same time, the sum of the individual branch diameters must not exceed the maximum branch diameter.

The best shredding performance is achieved with freshly cut tree and hedge clippings.

### 8.4 Working area for operator



- For safety reasons, the operator must stay within the working area (grey area X) for the entire operating period (while the motor is switched on or the engine is running), particularly in order to prevent injuries due to shredding material that is ejected backwards.

To feed shredding material, stand slightly to the side of the feed chute.

#### Risk of injury!



The inclined blade unit can cause hard material to kick back. Hard material kickback may result in serious injury to the user. To avoid injury from kickback, never stand directly behind the feed chute.

### 8.5 Correct machine load

The load on the motor or engine of the garden shredder must never cause the speed to drop significantly. Always feed the garden shredder continuously and steadily. If the speed drops when working

### 8.1 What material can be processed?

Organic plant trimmings such as fruit and vegetable cuttings, flower cuttings, leaves, tree and hedge cuttings, as well as thick branches with side shoots and twigs.

#### Risk of injury!



Tree and hedge cuttings should be processed when fresh, as the shredding performance is better with fresh than with dried-out or wet shredding material. Processing dry hard material increases the risk of kickback. Branch kickback may result in severe injury to the user.

### 8.2 What material cannot be processed?

Stones, glass, bits of metal (wire, nails, etc.) or plastic must not be fed into the garden shredder.

#### As a general rule:

Any materials that do not belong on the compost heap should not be processed using the garden shredder.

with the garden shredder, stop feeding the machine in order to relieve the load on the motor or engine.

### 8.6 Overload protection

If an overload of the motor occurs during operation, the built-in overload protection device automatically switches off the motor.

The garden shredder can be started up

again after a cooling period of **approx. 10 minutes**. Frequent triggering of the overload protection may be attributable to the following causes:

- Unsuitable electric cable (⇒ 10.1)
- Power overload
- Machine overloaded due to excessive quantities of shredding material or blunt blades

### 8.7 If the cutting unit of the garden shredder is blocked

If the cutting unit of the garden shredder becomes blocked during shredding, immediately switch off the motor and disconnect the power cable. Then remove the feed chute and eliminate the cause of the fault.

### 8.8 Correct way to feed the garden shredder



#### Risk of injury!

The inclined blade unit can cause branches to kick back. Branch kickback may result in severe injury to the user. In order to prevent injuries caused by kickback, feed the material into the garden shredder in the correct manner.

#### Soft material:

- Feed organic plant trimmings such as fruit and vegetable waste, flower cuttings, leaves, thin branches, etc. into large rectangular opening (1).

#### Hard material:



When feeding with hard material, note the maximum branch diameter specified. Thin out any branches with numerous twigs and remove side shoots.

- Feed tree and hedge cuttings and branch material slowly into the STIHL cloverleaf opening (2), guiding it along the right chute wall to the blade unit. The hard material is automatically drawn in by the machine.

## 9. Safety devices

### 9.1 Motor restart inhibitor

The machine can only be started via the switch and not by plugging the electric cable into the mains socket.

### 9.2 Safety interlock

The motor/shredding tool may only be operated when the feed chute has been properly closed. If the right closure screw (machine viewed from the front) becomes loose during operation, the motor is switched off automatically and after a few seconds the shredding tool comes to a standstill.

### 9.3 Motor run-down brake

The motor run-down brake shortens the run-down time from when the machine is switched off until the blades stop to a few seconds.

### 9.4 Protective covers

The garden shredder is equipped with protective covers in the feeding and ejection areas. These include the complete feed chute with the upper chute and splash guard, the ejection chute extension and the discharge flap.

The protective covers ensure that a safe distance is maintained from the shredding blades.

## 10. Operating the machine



Carefully read the section entitled "For your safety" (⇒ 4.) and follow all the safety instructions before operating the garden shredder.

- Switch on the motor only as described in the operating instructions. (⇒ 10.3)

DE

EN

FR

NL

IT

ES

PT

NO

SV

FI

DA

PL

SL

SK

HU

### 10.1 Electrical connection of garden shredders



#### Risk of injury!

Observe all safety instructions in the chapter "Warning - Dangers due to electrical current" (⇒ 4.2).

Power supply and operating voltage must correspond (see rating plate).

The power cable must be adequately protected by fuse. (⇒ 17.)

Only electric cables which are no lighter than rubber sheathed cables

**H07 RN-F DIN/VDE 0282** may be used.

The minimum cross-section of the power cable must be **3 x 1.5 mm<sup>2</sup>** for a length of **up to 25 m** or **3 x 2.5 mm<sup>2</sup>** for a length of **over 25 m**.

The connectors of the electric cable must be made of rubber or have a rubber coating and conform to the **DIN/VDE 0620** standard.

The plug connections must be splash proof.

Unsuitable extension cables lead to a loss of power and may result in damage to the motor.

This machine is intended for operation with a power supply having a system impedance of  $Z_{max}$  at the transfer point (house connection) of maximum

**0.279 ohms at 50 Hz**.

The user must ensure that the machine is only operated with a power supply that meets this requirement.

If necessary, this information can be obtained from the local electric power company.

### 10.2 Connecting the power cable



- Lift clip (1).
- Connect power cable connector.
- Release clip.

### 10.3 Switching on the garden shredder



- Connect the power cable. (⇒ 10.2)
- Press the green button (1) on the switch.  
Only begin to feed the shredding material once the motor has reached the maximum speed (idling speed).

### 10.4 Switching off the garden shredder



- Press the red button (1) on the switch. The garden shredder motor is switched off and braked automatically.

### 10.5 Shredding



It is only permitted for one person to feed the garden shredder.

- Push the garden shredder onto firm and level ground and set down safely.
- Put on thick gloves, safety glasses and hearing protection.
- Open the discharge flap. (⇒ 7.4)
- Connect the power cable to the garden shredder. (⇒ 10.2)
- Start the garden shredder. (⇒ 10.3)

- Wait until the garden shredder has reached its maximum speed (idling speed).

- Feed the garden shredder with shredding material in the correct way. (⇒ 8.8)

- Switch off the garden shredder. (⇒ 10.4)

## 11. Maintenance



#### Risk of injury!

In order to prevent inadvertent starting of the motor, always disconnect the power cable prior to all maintenance and cleaning operations, and prior to work on the cutting unit.

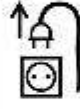

#### Risk of injury!

Always wear protective gloves. (⇒ 4.3)  
Do not touch the blades until they have come to a standstill.



If you do not have the necessary expertise or auxiliary equipment, please always contact a specialist dealer.

STIHL recommends that you have maintenance operations and repairs performed exclusively by a STIHL specialist dealer.

STIHL recommends the use of original STIHL spare parts.

### 11.1 Cleaning the machine



#### Maintenance interval: After each use

Clean the machine thoroughly each time it has been used. Care of the machine will protect it against damage and extend its service life.

Electric motors are splashproof.

Protect shredding tools, incl. the shredding chamber using a commercially available anti-corrosion agent (e.g. rapeseed oil).

It is only permitted to clean the machine in the position shown.

- Remove the feed chute. (⇒ 11.2)

Remove dirt from the cooling air guide (inlet slots) on the motor housing to ensure that the motor is adequately cooled.



**Never spray water** onto motor or engine components, seals, bearing points or electrical parts such as switches. This would result in expensive repairs.

If you are unable to remove the dirt and accumulated deposits with a brush, a damp cloth or a stick, STIHL recommends the use of a special cleaner (e.g. STIHL special cleaner).

Do not use aggressive cleaning agents.

Clean the blade discs regularly.

### 11.2 Removing the feed chute



#### Risk of injury!

Always disconnect the mains plug before removing the closure screws. Always wear protective gloves. (⇒ 4.3)

- Loosen both closure screws (1) until they turn freely. The screws are captive and remain in the feed chute.
- Pivot feed chute (2) to the rear and remove.

### 11.3 Installing the feed chute



#### Risk of injury!

Always wear protective gloves. (⇒ 4.3)

- Attach feed chute (1) to the fastening hooks on basic unit (2) and pivot forwards.
- Tighten both closure screws (3) **simultaneously**.



Following assembly, check by visual inspection that the feed chute is correctly engaged in the fastening hooks.

### 11.4 Locking the blade disc



The locking device must **always be tilted back** and secured with the bolt after installation of the blade disc and before operating the machine again (see illustration).

- Remove the feed chute. (⇒ 11.2)
- Loosen the screw (1).

- Turn the blade disc until the recess is located in front of the locking device (2).
- Insert the locking device (2) in the recess.
- Tighten the screw slightly (1).

### 11.5 Knife maintenance



#### Risk of injury!

Always wear thick gloves.



#### Maintenance interval: Before each use

- Remove the feed chute. (⇒ 11.2)
- Lock the blade disc. (⇒ 11.4)
- Check the blades for damage (notches or cracks) and wear; reverse or replace if necessary.

#### Wear limits of the blades:



The blades must be reversed or replaced before the specified wear limits are reached. STIHL recommends STIHL specialist dealers.

#### Reversible blade

- On the blades, measure the distance (A) between the bore to the edge of the blade at several points.  
**Minimum distance 6 mm**

DE

EN

FR

NL

IT

ES

PT

NO

SV

FI

DA

PL

SL

SK

HU

## 2 Wing blade

- Measure the blade width (B) at the upward-pointing curved edge of the wing blade.

**Minimum blade width 18 mm**

### Removing the blade set:



Do not touch the blades until they have come to a standstill.

- Lock the blade disc. (⇒ 11.4)
- Loosen bolt (1).
- Remove bolt (1), wing blade (2) and blade disc (3).

### Fit the blade set:



Before using the blade set, visually check that the blade disc and all shredding blades are OK and have no notches, cracks or pieces chipped out.

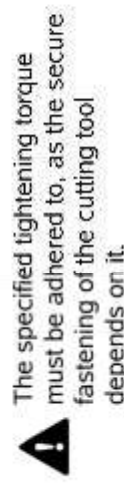

- Insert and secure the blade disc (3). (⇒ 11.4)
- Fit the wing blade (2) and screw in the bolt (1) (25 Nm).

- Push back the locking device and fix it with the screw so that the blade disc can rotate freely again. (⇒ 11.4)

### Reversing the blades:

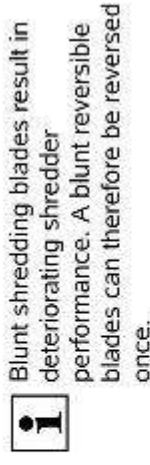

- Remove the blade disc, then loosen screws (4) and remove together with nuts (5).
- Lift off blade (6).
- Clean the blade disc.
- Reverse blade (6) and place onto the blade disc with the sharp edge exposed and align the bores.
- Insert screws (4) through the bores and screw on nuts (5). Tighten the nuts (5) to 10 Nm.

### Sharpening the blades:



- Remove the blades for sharpening.

- Cool the blades when sharpening, e.g. with water. The blades must not be allowed to display blue colouring, as this would reduce their cutting quality.
- Sharpen the blades evenly to prevent vibrations due to imbalance.
- Check blades for damage before installing: the blades must be replaced if notches or cracks are visible or if the blades have reached the wear limits.
- Sharpen blades at a sharpening angle of 30°.
- Sharpen the blades against the cutting edge.
- After sharpening, remove any sharpening burr at the cutting edge using fine sandpaper.
- Observe the tightening torques contained in the "Reversing the blades" section when installing the blades.

## 11.6 Electric motor and wheels

The electric motor is maintenance-free. The wheel bearings are maintenance-free.

## 11.7 Storage and winter break

Store the garden shredder in a dry and locked place that is generally free of dust. Make sure that the machine is kept out of the reach of children.

Only store the garden shredder in good operating condition and with the feed chute fitted.

Note the following points when storing the garden shredder for extended periods (over winter):

- Thoroughly clean all external parts of the machine.
- Thoroughly lubricate/grease all moving parts.

## 12. Transport



### Risk of injury!

Before transporting, carefully read and observe the section "For your safety", in particular the "Transporting the machine" section. (⇒ 4.4)

### 12.1 Lifting or carrying the garden shredder



- At least two persons are always required to lift and carry the machine.

Wear suitable protective clothing; the lower arms and upper part of the body must be fully covered.

- 1. First person: Hold the garden shredder at the handle on the upper chute (1).
- 2. Second person: Hold the garden shredder at the bar of the ejection chute extension (2).
- Lift the garden shredder simultaneously.

### 12.2 Pulling or pushing the garden shredder



- Hold the garden shredder at the handle (1) and tilt to the rear.

- The garden shredder can be pulled or pushed slowly (walking pace).

### 12.3 Transporting the garden shredder on a load floor



- Secure the machine against slipping using suitable fastening materials. Attach ropes or straps to the wheel carrier (1) or the feed chute (2).

## 13. Minimising wear and preventing damage

### Important information on maintenance and care of the product group

#### Electric garden shredder (STIHL GHE)

STIHL assumes no liability for material or personal damage caused by the non-observance of information contained in the operating instructions, in particular with regard to safety, operation and maintenance, or which arise through the use of unauthorised attachment or spare parts.

Please always observe the following important information for the prevention of damage or excessive wear to your STIHL machine:

#### 1. Wearing parts

Some parts of the STIHL machine are subject to normal wear even when used properly and must be replaced in due time depending on type and duration of use.

These include:

- Blade
- Blade disc

## 2. Compliance with the information in this instruction manual

The STIHL machine must be used, maintained and stored with the care described in this instruction manual. Any damage caused by non-compliance with the safety, operating and maintenance instructions is the sole responsibility of the user.

This applies in particular to:

- Inadequately dimensioned power cables (cross section)
- Incorrect electrical connection (voltage)
- Product modifications not approved by STIHL
- Use of tools or accessories which are not approved or suitable for the machine, or are of inferior quality
- Improper use of the product
- Use of the product for sporting or competitive events
- Resultant damage due to continued use of the product with defective components.

## 3. Maintenance operations

All operations listed in the section "Maintenance" must be performed regularly.

If these maintenance operations cannot be carried out by the user, a specialist dealer must be commissioned to perform them.

STIHL recommends that you have maintenance operations and repairs performed exclusively by a STIHL specialist dealer.

STIHL specialist dealers regularly attend training courses and are provided with technical information.

DE

EN

FR

NL

IT

ES

PT

NO

SV

FI

DA

PL

SL

SK

HU

If these operations are neglected, faults may arise which are the responsibility of the user.

These include:

- Damage to the motor as a result of inadequate cleaning of the cooling air guide (inlet slots, cooling ribs, fan wheel).
- Corrosive and other resultant damage caused by incorrect storage.
- Damage to the machine through the use of inferior-quality spare parts.
- Damage due to untimely or inadequate maintenance or damage due to maintenance or repair work not performed in the workshops of specialist dealers.

## 14. Standard spare parts

Blade:

6008 702 0121

Wing blade:

6007 702 0300

Blade disc assembly:

6007 700 5190

## 15. Environmental protection



Shredding material should be composted and not disposed of in household waste.

The machine, its packaging and accessories are all produced from recyclable materials and must be disposed of accordingly.

By disposing of materials separately and in an environmentally friendly manner, recyclable waste can be re-used. For this reason, the machine should be disposed of for recycling at the end of its useful life. Improper disposal may be harmful to health and pollute the environment.

## 16. Declaration of conformity

### 16.1 EU declaration of conformity – STIHL GHE 105.0 garden shredder

STIHL Tirol GmbH  
Hans Peter Stihl-Strasse 5  
6336 Langkampfen  
Austria

declares under our sole responsibility that

- design: electric garden shredder
- manufacturer's brand: STIHL
- type: GHE 105.0
- power: 2200 W
- serial number: 6007

complies with the relevant provisions of Directives 2000/14/EC, 2006/42/EC, 2014/30/EU and 2011/65/EU and has been developed and manufactured in accordance with the versions of the following standards valid on the date of manufacture: EN ISO 12100, EN 50434, EN 13683 section 5.2.1.4, EN 60335-1, EN 55014-1 and EN 55014-2.

The measured and guaranteed sound power levels were determined in accordance with Directive 2000/14/EC, Appendix V.

- Measured sound power level:  
100.8 dB(A)

- Guaranteed sound power level:  
104 dB(A)

The technical documents are stored at STIHL Tirol GmbH.

The year of manufacture and machine number are indicated on the garden shredder.

Langkampfen, 31.05.2024

STIHL Tirol GmbH

p.p.

Matthias Fleischer, Head of Product Development

p.p.

Sven Zimmermann, Head of Quality Department

### 16.2 UKCA-Declaration of Conformity STIHL GHE 105.0 Garden Shredder

STIHL Tirol GmbH  
Hans Peter Stihl-Strasse 5  
6336 Langkampfen  
Austria

declares under our sole responsibility that

- design: garden shredder
- manufacturer's brand: STIHL
- type: GHE 105.0

- power input: 2200 W
- serial number: 6007

complies with the relevant provisions of UK Regulations Noise Emission in the Environment by Equipment for use Outdoors Regulations 2001, Supply of Machinery (Safety) Regulations 2008, Electromagnetic Compatibility Regulations 2016 and The Restriction of the Use of Certain Hazardous Substances in Electrical and Electronic Equipment Regulations 2012 and has been developed and manufactured in accordance with the versions of the following standards valid on the date of manufacture: EN ISO 12100, EN 50434, EN 13683 cl. 5.2.1.4, EN 60335-1, EN 55014-1 and EN 55014-2.

The measured and guaranteed sound power levels were determined in accordance with the Noise Emission in the Environment by Equipment for use Outdoors Regulations 2001, Schedule 8.

- Measured sound power level: 100.8 dB(A)
- Guaranteed sound power level: 104 dB(A)

The technical documents are stored at STIHL Tirol GmbH.

The year of manufacture and machine number are indicated on the garden shredder.

Langkampfen, 31.05.2024

STIHL Tirol GmbH

p.p.



Matthias Fleischer, Head of Product Development

p.p.



Sven Zimmermann, Head of Quality Division

## GHE 105.0

Tightening torque	25 Nm
Blade disc screw	
Tightening torque Reversible blade screw	10 Nm
L/W/H	77/48/97 cm
Weight	19 kg
	19 kg (CH)
	20 kg (GB)

### Sound emissions:

In accordance with 2000/14/EC / S.I. 2001/1701:

Guaranteed sound power level $L_{wAd}$	104 dB(A)
Uncertainty $K_{wA}$	3 dB(A)
In accordance with EN 50434:	
Sound pressure level at workplace $L_{pA}$	93 dB(A)
Uncertainty $K_{pA}$	3 dB(A)

### \* Attention!

Mains fuses of less than 16 A may frequently trip during start-up of the machine or when it is operating under heavy load.

### 17.1 REACH

REACH is an EC Regulation for the registration, evaluation and restriction of chemicals.

Information on compliance with the REACH Regulation (EC) No. 1907/2006 is available from [www.stihl.com/reach](http://www.stihl.com/reach).

## 17. Technical specifications

### GHE 105.0

Power	2200 W
Amperage rating	9.8 A
Rated voltage	230 V
Frequency	50 Hz
Speed	2800 rpm
Mains fuse	16 A*
Protection class	I
Type of protection	Splash proof (IPX4)
Operating conditions	P40
	40 s load time
	60 s idle time

DE

EN

FR

NL

IT

ES

PT

NO

SV

FI

DA

PL

SL

SK

HU



## 18. Troubleshooting

- ✂ If necessary, contact a specialist dealer; STIHL recommends STIHL specialist dealers.

### Fault:

Motor does not start

### Possible cause:

- Motor overload protection activated
- No mains voltage
- Electric cable, plug, plug connector or switch defective
- Fuse in UK plug damaged (only applies to machines for UK)
- Feed chute not properly closed - safety cut-off switch actuated (safety interlock)
- Blade disc blocked
- Locking device is not reset

### Remedy:

- Allow machine to cool down (⇒ 8.6)
- Check power cable and fuse ✂ (⇒ 10.1)
- Check cable, plug, connector and switch and replace if necessary (by electrician) ✂ (⇒ 10.1)
- Replace fuse ✂
- Close feed chute properly and tighten screws (→ 11.3)
- Remove feed chute and remove shredder deposits from the housing (important: disconnect the power cable) (⇒ 11.2)
- Reset locking device (⇒ 11.4)

### Fault:

Frequently tripped mains fuse

### Possible cause:

- Unsuitable electric cable
- Power overload

- Machine overloaded

### Remedy:

- Use suitable electric cable (⇒ 10.1)
- Connect the machine to another circuit
- Reduce quantity of shredding material; reverse, re-sharpen or replace the shredding blades ✂ (⇒ 11.5)

### Fault:

Reduced shredding performance

### Possible cause:

- Blunt blades

### Remedy:

- Reverse, re-sharpen or replace shredding blades ✂ (⇒ 11.5)

## 19. Service schedule

### 19.1 Handover confirmation

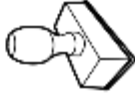
<b>Model:</b>	_____
<b>Serial number:</b>	<input type="text"/> <input type="text"/> <input type="text"/> <input type="text"/> <input type="text"/> <input type="text"/> <input type="text"/> <input type="text"/> <input type="text"/> <input type="text"/>
<b>Date:</b>	____ ____ ____ ____ ____ ____ ____ ____ ____ ____
	
Next service	
<b>Date:</b>	____ ____ ____ ____ ____ ____ ____ ____ ____ ____

### 19.2 Service confirmation

Please hand this instruction manual to your STIHL specialist dealer in the case of maintenance operations. He will confirm the service operations performed in the pre-printed boxes.



Service performed on



Next service date