

FS 240

STIHL



2 - 24 Instruction Manual



Contents

- 1 Introduction..... 2
- 2 Guide to Using this Manual..... 2
- 3 Overview..... 3
- 4 Safety Precautions..... 4
- 5 Preparing Trimmer for Operation..... 11
- 6 Assembling the Trimmer..... 11
- 7 Adjusting Trimmer for User..... 13
- 8 Mixing Fuel and Refueling the Brushcutter
..... 14
- 9 Starting and Stopping the Engine..... 15
- 10 Testing the Trimmer..... 16
- 11 Operating the Trimmer..... 16
- 12 After Finishing Work..... 18
- 13 Transporting..... 18
- 14 Storing..... 18
- 15 Cleaning..... 19
- 16 Maintenance..... 19
- 17 Repairing..... 19
- 18 Troubleshooting..... 20
- 19 Specifications..... 21
- 20 Combinations of Cutting Attachments,
Deflectors and Carrying Systems..... 22
- 21 Approved Power Tool Attachments..... 22
- 22 Spare Parts and Accessories..... 22
- 23 Disposal..... 23
- 24 EC Declaration of Conformity..... 23
- 25 UKCA Declaration of Conformity..... 23

1 Introduction

Dear Customer,

Thank you for choosing STIHL. We develop and manufacture our quality products to meet our customers' requirements. The products are designed for reliability even under extreme conditions.

STIHL also stands for premium service quality. Our dealers guarantee competent advice and instruction as well as comprehensive service support.

STIHL expressly commit themselves to a sustainable and responsible handling of natural resources. This user manual is intended to help you use your STIHL product safely and in an environmentally friendly manner over a long service life.

We thank you for your confidence in us and hope you will enjoy working with your STIHL product.

Dr. Nikolas Stihl

IMPORTANT! READ BEFORE USING AND KEEP IN A SAFE PLACE FOR REFERENCE.

2 Guide to Using this Manual

2.1 Applicable Documentation

Local safety regulations apply.

- ▶ Read, understand and save the following documents in addition to this instruction manual:
 - Instruction manual and packaging of the cutting attachment you are using

2.2 Symbols used with warnings in the text



WARNING

- This symbol indicates dangers that can cause serious injuries or death.
 - ▶ The measures indicated can avoid serious injuries or death.



NOTICE

- This symbol indicates dangers that can cause damage to property.
 - ▶ The measures indicated can avoid damage to property.

2.3 Symbols in Text



This symbol refers to a chapter in this instruction manual.

3 Overview

3.1 Brushcutter

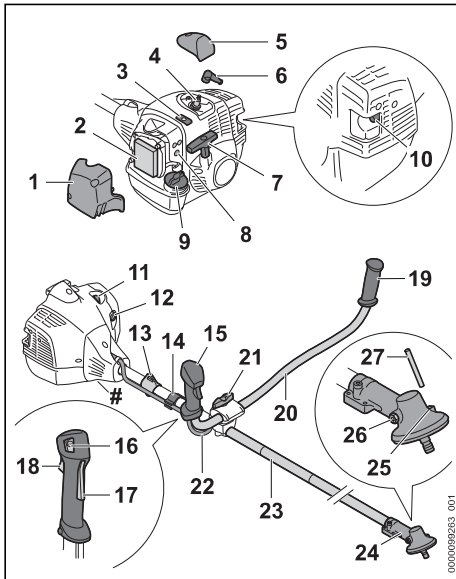

1 Filter cover

Covers the air filter.

2 Air filter

The air filter filters the air entering the engine.

3 Shutter

The shutter is used to select summer or winter operating mode.

4 Spark plug

The spark plug ignites the fuel-air mixture in the engine.

5 Cover

Covers the spark plug.

6 Spark plug boot

The spark plug boot connects the ignition lead to the spark plug.

7 Starter grip

Serves to crank the engine.

8 Carburetor adjusting screws

For tuning the carburetor.

9 Fuel tank cap

The fuel tank cap closes the fuel tank.

10 Muffler

The muffler reduces brushcutter noise emissions.

11 Manual fuel pump

The manual fuel pump makes it easier to start the engine.

12 Choke lever

The choke lever helps start the engine.

13 Carrying ring

The carrying ring is for attaching the carrying system.

14 Throttle cable retainer

The throttle cable retainer secures the throttle cable in position.

15 Control handle

The control handle is used for operating, holding and guiding the brushcutter.

16 Stop switch

The stop switch shuts off the engine.

17 Throttle trigger lockout

The throttle trigger lockout unlocks the throttle trigger.

18 Throttle trigger

The throttle trigger is used to control the engine speed.

19 Handle

The handle is for holding and guiding the brushcutter.

20 Handlebar

The handlebar connects control handle and handle with the shaft.

21 Wing screw

The wing screw secures the handlebar to the handle support.

22 Throttle cable

Connects the throttle trigger to the engine.

23 Shaft

The shaft connects all components.

24 Gear housing

The gear housing encloses the gearbox.

25 Opening for stop pin

The opening for the stop pin accommodates the stop pin.

26 Screw plug

The screw plug closes the filler opening for STIHL gear grease.

27 Stop pin

The stop pin blocks the shaft while a cutting attachment is being mounted.

Rating plate with machine number

3.2 Deflectors and Cutting Attachments

The illustrations show examples of deflectors and cutting attachments. Approved combinations are listed in this instruction manual, 20.

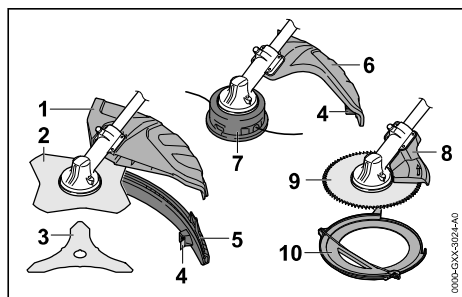

- 1 Universal deflector**
Protects user from flying debris and contact with the cutting attachment.
- 2 Grass Cutting Blade**
Cuts grass and weeds.
- 3 Brush Knife**
Cuts brushwood.
- 4 Line Limiting Blade**
Trims mowing line to correct length.
- 5 Skirt**
Extends universal deflector for use with a mowing head.
- 6 Deflector for Mowing Heads**
Protects user from flying debris and contact with the mowing head.
- 7 Mowing Head**
The mowing head contains the mowing line.
- 8 Limit Stop**
Protects user from flying debris and contact with the circular saw blade and helps support the trimmer against the wood during cutting work.
- 9 Circular Saw Blade**
Cuts shrubs and trees.
- 10 Transport Guard**
Helps protect user from contact with metal cutting attachments.

3.3 Symbols

Meanings of symbols that may be on the trimmer and the deflector:

This icon denotes the fuel tank.

- This symbol denotes the manual fuel pump.
- Shutter is in winter mode in this position.
- Shutter is in summer mode in this position.
- The engine is operated with the choke lever in this position.
- When warm, the engine is started with the choke lever in this position.
- When cold, the engine is started with the choke lever in this position.
- This symbol marks the stop switch.

- This icon shows the direction of rotation of the cutting attachment.
- max \varnothing XXX This icon shows the maximum diameter of the cutting attachment in millimeters.
- This icon shows the rated speed of the cutting attachment.
- L_{WA}** Guaranteed sound power level in accordance with Directive 2000/14/EC in dB(A) for the purpose of comparing the sound emissions of products.

4 Safety Precautions

4.1 Warning Signs

4.1.1 Warning Symbols

Meanings of warning signs on the trimmer:

- Observe safety notices and take the necessary precautions.
- Read, understand and save the instruction manual.
- Wear safety glasses, hearing protection and a hard hat.
- Wear safety boots.
- Wear work gloves.
- Observe safety notices on kickback and take the necessary precautions.



Observe safety notices on flying debris and take the necessary precautions.

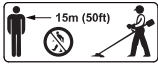

Maintain safe distance.



Do not touch hot surface.

4.1.2 Deflector for mowing heads

Meanings of warning signs and labels on the deflector for mowing heads:



Use this deflector for mowing heads.



Do not use this deflector for grass cutting blades.



Do not use this deflector for brush knives.



Do not use this deflector for shredder blades.



Do not use this deflector for circular saw blades.

4.1.3 Universal Deflector and Skirt

Universal deflector

Meanings of warning signs on the universal deflector:



Do not use this deflector without skirt for mowing heads.



Use this deflector for grass cutting blades.



Use this deflector for brush knives.



Use this deflector for shredder blades.



Do not use this deflector for circular saw blades.

Skirt

Meanings of warning signs on the skirt:



Use the universal deflector with skirt and line limiting blade for mowing heads.

4.2 Intended Use

The STIHL FS 240 brushcutter is designed for the following applications:

- with a mowing head: Mowing grass
- with a grass cutting blade: Mowing grass and weeds
- with a brush knife: Cutting brush with a stem diameter up to 20 mm
- with a circular saw blade: Cutting shrubs and trees with a stem diameter up to 40 mm

▲ WARNING

- Using the brushcutter for purposes which it is not designed for may result in serious or fatal injuries and damage to property.
 - ▶ Use the brushcutter as described in this User Manual.

4.3 The Operator

▲ WARNING

- Users who have had no instruction cannot recognize or assess the risks involved in using the trimmer. The user or other persons may sustain serious or fatal injuries.
 - ▶ Read, understand and save the instruction manual.
- ▶ If you pass the trimmer is on to another user: Always give them the instruction manual.
- ▶ Make sure the user meets the following requirements:
 - The user must be rested.
 - The user must be in good physical condition and mental health to operate and work with the trimmer. If the user's physical, sensory or mental ability is restricted, he or she may work only under the supervision of or as instructed by a responsible person.

- The user is able to recognize and assess the risks involved in using the trimmer.
- The user must be of legal age or is being trained in a trade under supervision in accordance with national rules and regulations.
- The user has received instruction from a STIHL servicing dealer or other experienced user before working with the trimmer for the first time.
- The user must not be under the influence of alcohol, medication or drugs.
- ▶ If you have any queries: Contact a STIHL servicing dealer for assistance.
- The trimmer's ignition system produces an electromagnetic field. This field may interfere with some pacemakers. This can result in serious or fatal injuries.
 - ▶ If the user has a pacemaker: Make sure the pacemaker is not affected.

4.4 Clothing and equipment

▲ WARNING

- Long hair can be drawn into the brushcutter during operation. This may result in serious injury to the user.
 - ▶ Tie up and confine long hair above your shoulders.
- Objects can be thrown at high speed during operation. This may result in injury to the user.
 - ▶ Wear close-fitting safety glasses. Suitable safety glasses are tested in accordance with EN 166 or national regulations and available commercially with the corresponding marking.



- ▶ Wear face protection.
- ▶ Wear long trousers made from resistant material.

- Noise is generated during operation. Noise can damage your hearing.



- ▶ Wear ear protection.

- Falling objects can cause head injuries.



- ▶ If objects are likely to fall while working: wear a hard hat.

- Dust can be whipped up during operation. Whipped up dust can damage the respiratory passages and cause allergic reactions.
 - ▶ If dust is generated: Wear a dust respirator mask.

- Inappropriate clothing can snag on wood, brush or the brushcutter. Users not wearing suitable clothing are at risk of serious injury.
 - ▶ Wear close-fitting clothing.
 - ▶ Remove scarves and jewelry.
- The user may come into contact with the rotating cutting attachment during operation. This may result in serious injury to the user.
 - ▶ Wear robust footwear.



- ▶ If you are using a metal cutting attachment: Wear steel-toed safety boots.



- ▶ Wear long trousers made from resistant material.

- When mounting and dismounting the cutting attachment and during cleaning or maintenance, the user may come into contact with the sharp edges of the cutting attachment or the crosscut blade. This may result in injury to the user.



- ▶ Wear work gloves made from resistant material.

- Wearing unsuitable footwear may cause the user to slip. This may result in injury to the user.
 - ▶ Wear sturdy, closed-toed footwear with high-grip soles.

4.5 Working Area and Surroundings

▲ WARNING

- Bystanders, children and animals are not aware of the dangers of the brushcutter or flying debris. This may result in serious injury to bystanders, children and animals and damage to property.



- ▶ Do not allow bystanders, children or animals within 15 meters of the work area.

- ▶ Maintain a clearance of 15 meters from objects.
- ▶ Do not leave the brushcutter unattended.
- ▶ Make sure that children cannot play with the brushcutter.
- Hot exhaust gas is emitted through the muffler while the engine is running. Hot exhaust gas can ignite easily flammable materials and cause a fire.
 - ▶ Keep exhaust gas well away from easily flammable materials.

4.6 Safe Condition

4.6.1 Brushcutter

The brushcutter is in a safe condition if the following points are observed:

- The brushcutter is not damaged.
- There is no fuel leaking from the trimmer.
- The fuel tank cap is closed.
- The brushcutter is clean.
- The controls function properly and have not been modified.
- A combination of cutting attachment and deflector recommended in this user manual is mounted.
- The cutting attachment and deflector are properly mounted.
- Genuine STIHL accessories for this brushcutter are fitted.
- The accessories are correctly attached.
- All accessible screws and fastening parts are firmly tightened.
- Cutting attachment does not run while engine is idling.

⚠ WARNING

- If not in safe condition, components may no longer operate correctly, safety devices may be disabled and fuel leakage may occur. There is a risk of serious or fatal injury.
 - ▶ Work only with an undamaged brushcutter.
 - ▶ If fuel is leaking from the trimmer: Do not use the trimmer and contact a STIHL dealer for assistance.
 - ▶ Close the fuel tank cap.
 - ▶ If the brushcutter is dirty: Clean the brushcutter.
 - ▶ Never attempt to modify your brushcutter. Exception: Mounting one of the combinations of cutting attachment and deflector recommended in this user manual.
 - ▶ If the controls do not function properly: Do not use your brushcutter.
 - ▶ Fit genuine STIHL accessories for this brushcutter.
 - ▶ Mount the cutting attachment and deflector as described in this user manual.
 - ▶ Attach accessories as described in this User Manual or in the User Manual for the accessories.
 - ▶ Tighten loose screws and fastening parts.
 - ▶ If the cutting attachment rotates when the engine is idling: Rectify the malfunction.
 - ▶ Never insert objects into the openings of the brushcutter.
 - ▶ Replace worn or damaged labels.

- ▶ If you are unsure: Consult a STIHL servicing dealer.

4.6.2 Deflector

The deflector is in a safe condition if the following points are observed:

- The deflector is not damaged.
- If the deflector is used for mowing heads: The line limiting blade is correctly installed.
- If you are using the universal deflector together with a mowing head: The line limiting blade and the skirt are correctly installed.

⚠ WARNING

- If not in safe condition, components may no longer operate correctly and safety devices may be rendered ineffective. This may result in serious injury to the user.
 - ▶ Work only with an undamaged deflector.
 - ▶ If the deflector for mowing heads is used: Work with a properly attached line limiting blade.
 - ▶ If you are using the universal deflector together with a mowing head: Work with a correctly installed line limiting blade and a correctly installed skirt.
 - ▶ If you are unsure, consult a STIHL dealer.

4.6.3 Mowing Head

The mowing head is in a safe condition if the following points are observed:

- The mowing head is not damaged.
- The mowing head is not jammed.
- The mowing head is correctly installed and firmly tightened.
- The mowing lines are properly installed.
- The wear limits are not exceeded.

⚠ WARNING

- If they are in an unsafe condition, parts of the mowing head or mowing lines may come off and be ejected at high speed. People may be seriously injured.
 - ▶ Work only with an undamaged mowing head.
 - ▶ Never use metal objects in place of the nylon mowing lines.
 - ▶ Observe and remain inside the wear limits.
 - ▶ If you are unsure: Consult a STIHL authorized dealer.

4.6.4 Metal cutting attachment

The metal cutting attachment is in a safe condition if the following points are observed:

- Metal cutting attachment and mounting hardware are undamaged.
- The metal cutting attachment is not warped.

- The metal cutting attachment is properly installed and firmly tightened.
- The metal cutting attachment is correctly sharpened.
- Cutting edges of the metal cutting attachment have no burrs.
- The wear limits are not exceeded.
- If a metal cutting attachment not manufactured by STIHL is used, it must not be heavier, thicker, of a different shape, of a lower quality, or larger in diameter than the largest metal cutting attachment approved by STIHL.

▲ WARNING

- If it is not in a safe condition, parts of the metal cutting attachment may come off and be thrown at high speed. People may be seriously injured.
 - ▶ Never work with a damaged metal cutting attachment or damaged mounting hardware.
 - ▶ Sharpen the metal cutting attachment correctly.
 - ▶ Deburr the cutting edges with a file.
 - ▶ Have the metal cutting attachment balanced by a STIHL servicing dealer.
 - ▶ Observe and remain inside the wear limits.
 - ▶ Use a metal cutting attachment specified in these instructions for use.
 - ▶ If you are unsure: Consult a STIHL authorized dealer.

4.7 Fuel Mixture and Refueling

▲ WARNING



- This brushcutter requires a fuel mixture of gasoline and two-stroke engine oil. Mixed fuel and gasoline are extremely flammable. If fuel mixture or gasoline make contact with open fire or hot objects, they can cause a fire or explosions. Persons may be seriously or fatally injured and property may be damaged.
 - ▶ Protect fuel mixture and gasoline from heat and fire.
 - ▶ Do not spill fuel mixture or gasoline.
 - ▶ If fuel is spilled: Wipe up fuel with a cloth and do not attempt to start engine until all parts of the brushcutter are dry.
 - ▶ Do not smoke.
 - ▶ Never refuel near a fire.
 - ▶ Shut off the engine and allow it to cool down before refueling.
 - ▶ Start the engine at least 3 meters from the fueling spot, outdoors only.
- Inhaling fuel fumes and gasoline fumes can have toxic effects.
 - ▶ Avoid inhaling fuel fumes or gasoline fumes.
 - ▶ Refuel in a well-ventilated location.
- The brushcutter becomes hot during operation. The fuel expands and excess pressure can build up in the tank. Fuel can escape as a spray when the fuel tank cap is opened. The escaping fuel can ignite. This may result in serious injury to the user.
 - ▶ Allow the brushcutter to cool down first and then open the fuel tank cap carefully.
- Clothing that has been in contact with fuel or gasoline will ignite more easily. Persons may be seriously or fatally injured and property may be damaged.
 - ▶ If your clothing comes into contact with fuel or gasoline: Change your clothing.
- Fuel mix, gasoline and two-stroke engine oil can harm the environment.
 - ▶ Do not spill fuel, gasoline or two-stroke engine oil.
 - ▶ Dispose of fuel mix, gasoline and two-stroke engine oil in accordance with local regulations and environmental requirements.
- Fuel, gasoline or two-stroke engine oil can cause irritation if they come into direct contact with the skin or eyes.
 - ▶ Avoid contact with fuel, gasoline and two-stroke engine oil.
 - ▶ If skin contact occurs: Wash affected areas of skin with plenty of water and soap.
 - ▶ If the event of contact with eyes: Rinse eyes with plenty of water for at least 15 minutes and consult a doctor.
- The brushcutter's ignition system produces sparks. Unconfined sparks may cause a fire or an explosion in an easily combustible or explosive environment. Persons may be seriously or fatally injured and property may be damaged.
 - ▶ Use the spark plugs described in this instruction manual.
 - ▶ Insert and tighten down the spark plug.
 - ▶ Connect the spark plug boot and press it down firmly.
- The brushcutter can become damaged if it is run with a fuel mixture that includes unsuitable gasoline or an unsuitable two-stroke engine oil, and also if an incorrect mix ratio of gasoline and two-stroke engine oil is used.
 - ▶ Mix the fuel as described in this User Manual.
- The mixture of gasoline and two-stroke engine oil can separate or age if it is stored for a long period. The brushcutter can be damaged if it is

used with a fuel mix that has become separated or has aged.

- ▶ Before refueling the brushcutter: Thoroughly mix the fuel.
- ▶ Use a mixture of gasoline and two-stroke engine oil that is not older than 30 days (STIHL MotoMix: 5 years).

4.8 Working

▲ WARNING

- If the engine is not started properly, the user may lose control of the trimmer. This may result in serious injury to the user.
 - ▶ Start the engine as described in this instruction manual.
 - ▶ If the cutting attachment is touching the ground or objects: Do not start the engine.
- In certain situations, the user may no longer be able to concentrate on their work. The user can lose control of the trimmer, stumble or fall and be seriously injured.
 - ▶ Keep calm and plan your work.
 - ▶ If light and visibility are poor: Do not use your trimmer.
 - ▶ Operate the trimmer alone.
 - ▶ Keep the cutting attachment close to the ground.
 - ▶ Watch out for obstacles.
 - ▶ Work standing on the ground and keep your balance.
 - ▶ If you start feeling fatigue: Take a break. If you start feeling fatigue: Take a break.
- Exhaust gas is produced when the engine is running. Breathing in exhaust gas can have toxic effects. Breathing in exhaust gas can have toxic effects.
 - ▶ Avoid inhaling exhaust gas.
 - ▶ Operate the trimmer in a well ventilated location.
 - ▶ In the event of nausea, headache, visual disturbances, problems with hearing or dizziness: Stop work and seek medical advice.
- The user's ability to hear and assess noises is restricted when wearing hearing protection with the engine running.
 - ▶ Work calmly and in a considered manner.
- If working with the brushcutter and the choke lever is in the  or  position, the user is not able to work with the brushcutter in a controlled manner. This could result in serious injury to the user.
 - ▶ Check that the choke lever is in position  during operation.
- ▶ Start the engine as described in this instruction manual.
- The rotating cutting attachment can cut the user. This may result in serious injury to the user.
 - ▶ Do not touch the rotating cutting attachment.
 - ▶ If the cutting attachment is blocked by an object: Shut off the engine. Before clearing the jam.
- If you work with mowing lines that are too long, the brush cutter may be damaged.
 - ▶ Use a suitable deflector with attached line limiting blade.
- The machine can be damaged if you open the throttle while the cutting attachment is blocked by an object.
 - ▶ Shut off the engine. before clearing the jam.
- If the behavior of the trimmer changes during operation or feels unusual, it may no longer be in a safe condition. This may result in serious injury to people and damage to property.
 - ▶ Stop work and consult a STIHL servicing dealer.
- Trimmer vibrations may occur during operation.
 - ▶ Wear gloves.
- ▶ Take breaks.
- ▶ If signs of a circulatory disturbance occur: Consult a doctor.
- If the cutting attachment makes contact with a foreign object during operation, the object or parts of it may be thrown at high speed. Persons may be injured or property damaged.
 - ▶ Remove foreign objects from the working area.
- If the rotating cutting attachment makes contact with a hard object, sparks may occur and the cutting attachment may be damaged. Sparks can cause fires in a flammable environment. Persons may be seriously or fatally injured and property may be damaged.
 - ▶ Do not use in a flammable environment.
 - ▶ Make sure the cutting attachment is in a safe condition.
- Note that the cutting attachment continues to rotate for a short period after you release the trigger. They may cause serious injury to persons.
 - ▶ Wait until the cutting attachment comes to a complete stop.



- In an emergency, the user may start to panic and forget to take off the carrying system. This may result in serious injury to the user.
 - ▶ Practice taking off the carrying system.

4.9 Reactive forces

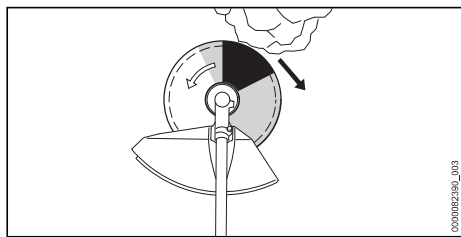

Kickout can be caused for the following reasons:

- The shaded area or the black area of the rotating metal cutting attachment comes into contact with a solid object and is suddenly braked.
- The rotating metal cutting attachment gets pinched in the cut.

The risk of kickout is greatest in the black area.

▲ WARNING

- These situations can abruptly decelerate or stop rotation of the cutting attachment and cause the cutting attachment to be thrown to the right or in the direction of the user (black arrow). The user can lose control of the trimmer. There is a risk of serious or fatal injury.
 - ▶ Hold the trimmer firmly with both hands.
 - ▶ Work as described in this User Manual.
 - ▶ Do not use the black area for cutting.
 - ▶ Use a combination of cutting attachment, deflector and carrying system recommended in this User Manual.
 - ▶ Sharpen the metal cutting attachment correctly.
 - ▶ Work with the engine running at full throttle.

4.10 Transporting

▲ WARNING

- The gearbox can get hot during operation. There is a risk of burn injuries.
 - ▶ Do not touch a hot gearbox.
- The trimmer may turn over or shift during transport. This may result in personal injuries and damage to property.
 - ▶ Shut off the engine.
 - ▶ If a metal cutting attachment is mounted: Fit the transport guard.
 - ▶ Secure the trimmer with lashing straps or a net to prevent it turning over and moving.

- The muffler and engine may be hot after a period of operation. There is a risk of burn injuries.
 - ▶ Carry the trimmer properly balanced by the drive tube with the cutting attachment behind you.

4.11 Storing

▲ WARNING

- Children are not aware of and cannot assess the dangers of a trimmer and can be seriously injured.
 - ▶ Shut off the engine.
 - ▶ If a metal cutting attachment is mounted: Fit the transport guard.
 - ▶ Store the trimmer out of the reach of children.
 - ▶ Store the trimmer in a stable position and secured against falling over.
- Dampness can corrode the electrical contacts on the trimmer and metal components. This can damage the trimmer.
 - ▶ Store the trimmer in a clean and dry condition.

4.12 Cleaning, maintenance and repair

▲ WARNING

- The cutting attachment can start rotating unintentionally if the engine is running during cleaning, maintenance or repair operations. This may result in serious injury to people and damage to property.
 - ▶ Shut off the engine.
- The muffler and engine may be hot after a period of operation. This can result in burn injuries.
 - ▶ Wait until the muffler and engine cool down.
- The gear housing can get hot during operation. There is a risk of burn injuries.
 - ▶ Do not touch a hot gear housing.



- Aggressive cleaning agents, a water jet or pointed objects can damage the trimmer, deflector or the cutting attachment. If the trimmer, deflector and cutting attachment are not cleaned correctly, components may no longer function properly or safety devices may be rendered inoperative. Persons may be seriously injured.

- ▶ Clean the brushcutter, deflector and cutting attachment as described in this User Manual.
- If the brushcutter, deflector or cutting attachment is not maintained or repaired as described in this User Manual, components may no longer function properly or safety devices may be rendered inoperative. This can result in serious or fatal injuries.
 - ▶ Maintain or repair the brushcutter and the deflector as described in this User Manual.
 - ▶ Maintain the cutting attachment as described in the User Manual supplied with the cutting attachment being used or on the cutting attachment's packaging.
- The user can be cut by the sharp cutting edges while cleaning or maintaining cutting attachments. This may result in injury to the user.



- ▶ Wear work gloves made of robust material.

5 Preparing Trimmer for Operation

5.1 Preparing the Brushcutter for Operation

The following steps must be performed before commencing work:

- ▶ Ensure that the following components are in safe condition:
 - Brushcutter, [15.1](#).
 - Deflector, [4.6.2](#).
 - Mowing head or metal cutting attachment, [4.6.3](#) or [4.6.4](#).
- ▶ Clean the brushcutter, [15.1](#).
- ▶ Fit the carrying ring, [6.1](#).
- ▶ Mount the bike handle, [6.2](#).
- ▶ Select combination of cutting attachment, deflector and carrying system, [20](#).
- ▶ Mount the deflector, [6.3.1](#).
- ▶ If you are using a universal deflector together with a mowing head: Fit the skirt and line limiting blade, [6.4.1](#).
- ▶ Mount mowing head or metal cutting attachment, [6.5.1](#) or [6.6.1](#).
- ▶ Fuel the trimmer, [8.2](#).
- ▶ Fit and adjust the carrying system, [7.1](#).
- ▶ Adjust the bike handle, [7.2](#).
- ▶ Balance the brushcutter, [7.3](#).
- ▶ Check the controls, [10.1](#).

- ▶ If you cannot carry out this work: Do not use your brushcutter and contact your STIHL dealer for assistance.

6 Assembling the Trimmer

6.1 Fitting the Carrying Ring

- ▶ Shut off the engine.

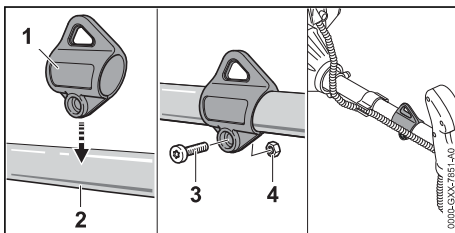

- ▶ Hold the carrying ring (1) against the drive tube (2) and then press it into position.
- ▶ Fit the nut (4).
- ▶ Insert and tighten down the screw (3) firmly.

The carrying ring need not be removed again.

6.2 Mounting the Bike Handle

- ▶ Shut off the engine.

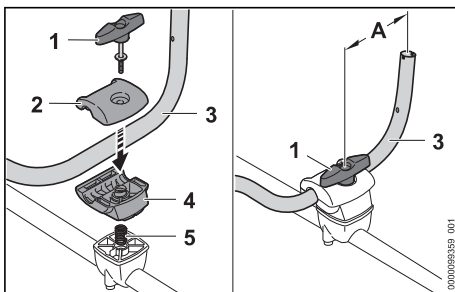

- ▶ Remove the wing screw (1).
- ▶ Remove the clamp moldings (2 and 4).
- ▶ Place the handlebar (3) in the lower clamp molding (4).
- ▶ Fit the upper clamp molding (2).
- ▶ Insert the spring (5) from below into the lower clamp molding (4).
- ▶ Place the clamp shells (2 and 4) on the shaft and insert the wing screw (1).
- ▶ Pivot the handlebar (3) up and align it so that distance (A) is about 15 cm. While doing so, do not clamp the curved part of the handlebar (3).
- ▶ Tighten the wing screw (1).

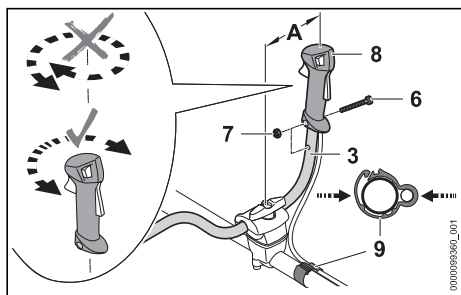

- ▶ Remove the screw (6).
- ▶ Position the control handle (8) on the handlebar (3), trigger facing the gear housing, and line up the hole in the control handle with the hole in the handlebar. When doing so, do not twist the operating handle (8).
- ▶ Fit the nut (7).
- ▶ Insert the screw (6) and secure it firmly.
- ▶ Position the throttle cable retainer (9) and the throttle cable on the shaft. The throttle cable must not be kinked or too tightly constricted – make sure the throttle trigger moves freely.
- ▶ Press the throttle cable retainer (9) together. The throttle cable retainer (9) engages in position with an audible click.

The bike handle can be left on the shaft.

6.3 Removing the Deflector and the Limit Stop

6.3.1 Mounting the Deflector

- ▶ Shut off the engine.

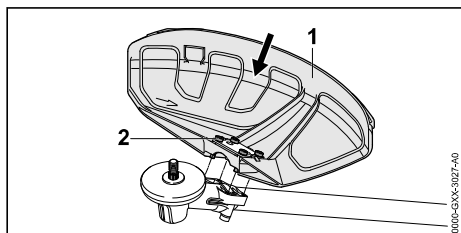

- ▶ Push the deflector (1) into the guides on the gear housing up to the limit stop.
- ▶ Insert and tighten the screws (2).

6.3.2 Removing the Deflector

- ▶ Shut off the engine.
- ▶ Take out screws.
- ▶ Remove guard.

6.4 Fitting and Removing the Skirt

6.4.1 Fitting the Skirt

- ▶ Shut off the engine.

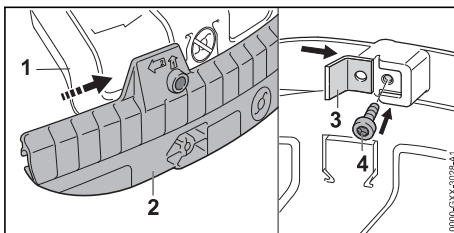

- ▶ Slide the guide slot in the skirt (2) onto the deflector (1) – it must snap into position.
- ▶ Push the line limiting blade (3) into the slot in the skirt (2).
- ▶ Insert and tighten down the screw (4) firmly.

6.4.2 Removing the Skirt

- ▶ Shut off the engine.

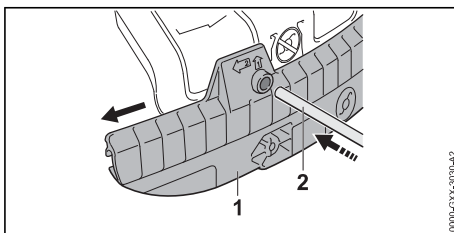

- ▶ Insert stop pin (2) into the hole in the skirt (1).
- ▶ Use the stop pin (2) to slide the skirt (1) off the deflector.

The line limiting blade (1) can be left on the skirt.

6.5 Mounting and Removing the Mowing Head

6.5.1 Mounting the Mowing Head

- ▶ Shut off the engine.

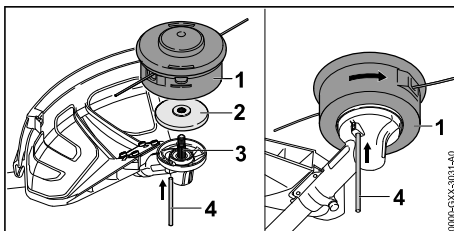

- ▶ Place the thrust plate (2) on the shaft (3) so that its smaller diameter faces up.
- ▶ Fit the mowing head (1) on the shaft (3) and turn it counterclockwise by hand.

- ▶ Insert the stop pin (4) in the bore up to the limit stop and hold it depressed.
- ▶ Turn the mowing head (1) counterclockwise until the stop pin (4) engages in position. The shaft (3) is now blocked.
- ▶ Tighten down the mowing head (1) firmly by hand.
- ▶ Remove the stop pin (4).

6.5.2 Removing the Mowing Head

- ▶ Shut off the engine.
- ▶ Insert the stop pin in the bore as far as stop and hold it depressed.
- ▶ Rotate the mowing head until the stop pin engages in position. The shaft is now blocked.
- ▶ Unscrew the mowing head clockwise.
- ▶ Remove the thrust plate.
- ▶ Remove stop pin.

6.6 Removing and Installing Metal Cutting Attachment

6.6.1 Mounting the Metal Cutting Attachment

- ▶ Shut off the engine.

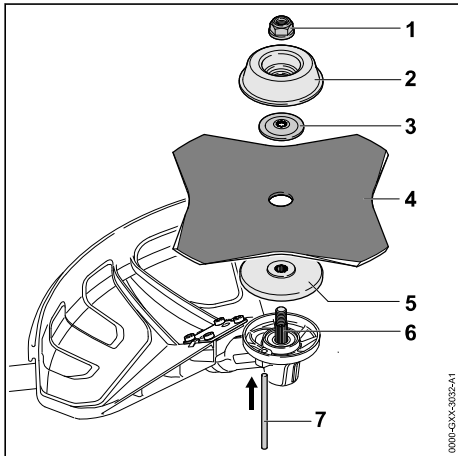

- ▶ Place the thrust plate (5) on the shaft (6) so that its smaller diameter faces up.
- ▶ Place the metal cutting attachment (4) on the thrust plate (5). If you are fitting a circular saw blade or a grass cutting blade with more than 4 cutting edges: Its cutting edges must face in the same direction as the arrow on the deflector.
- ▶ Place the thrust washer (3) on the metal cutting attachment (4) so that its raised side faces up.

- ▶ Place the rider plate (2) on the thrust washer (3) so that its closed side faces up.
- ▶ Insert the stop pin (7) in the bore as far as stop and hold it depressed.
- ▶ Rotate the metal cutting attachment (4) counterclockwise until the stop pin (7) engages in position. The shaft (6) is now blocked.
- ▶ Fit the nut (1) counterclockwise and tighten it down firmly.
- ▶ Remove the stop pin (7).

6.6.2 Removing the metal cutting attachment

- ▶ Shut off the engine.
- ▶ Insert the stop pin in the bore up to the limit stop and hold it depressed.
- ▶ Rotate the metal cutting attachment clockwise until the stop pin engages in position. The shaft is now blocked.
- ▶ Unscrew the mounting nut clockwise.
- ▶ Remove the fastening parts, metal cutting tool and pressure plate.
- ▶ Remove the stop pin.

7 Adjusting Trimmer for User

7.1 Fitting and Adjusting the Carrying System

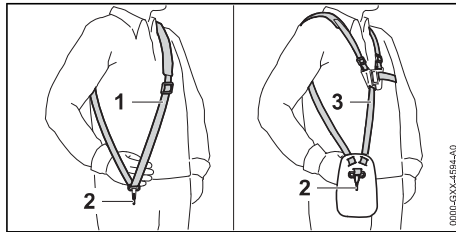

- ▶ Put on the shoulder strap (1) or full harness (3).
- ▶ Adjust the shoulder strap (1) or full harness (3) so that the carabiner (2) is about a hand's width below your right hip.

7.2 Adjusting the Bike Handle

The bike handle can be set to different positions to suit the height and reach of the user.

- ▶ Shut off the engine.
- ▶ Use the carrying ring to hook the brushcutter into the carabiner of the carrying system.

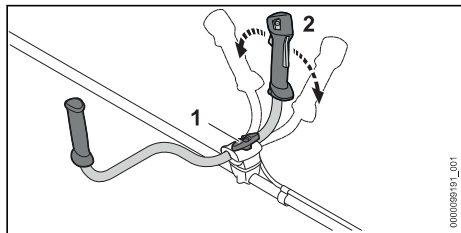

- ▶ Loosen the wing screw (1).
- ▶ Swing the bike handle (2) to the required position.
- ▶ Firmly tighten the wing screw (1).

7.3 Balancing the Trimmer

The unit is balanced differently depending on the cutting attachment used.

If a mowing head, grass cutting blade or brush knife is fitted:

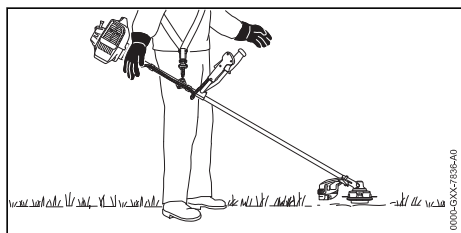

The cutting attachment should rest lightly on the ground.

If a circular saw blade is fitted:

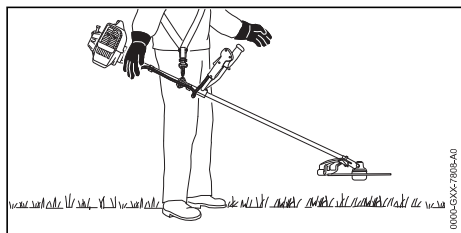

The saw blade must hover at a height of about 20 cm above the ground.

- ▶ Shut off the engine.

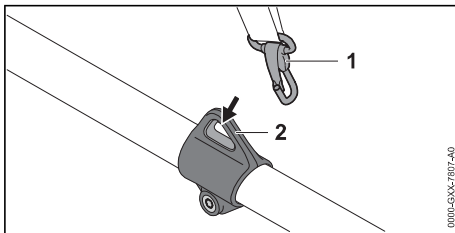

- ▶ Connect the carrying ring (2) to the carabiner (1).
- ▶ Wait for the trimmer to stop swinging.
- ▶ Check position of cutting attachment. If it needs adjustment:

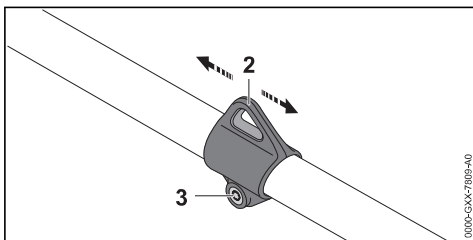

- ▶ Loosen the screw (3).
- ▶ Move carrying ring (2) up or down the drive tube until correct balanced position is reached.
- ▶ Tighten down the screw (3) firmly.

8 Mixing Fuel and Refueling the Brushcutter

8.1 Mixing fuel

The fuel required for this trimmer is a mixture of gasoline and two-stroke engine oil, in a mixing ratio of 1:50.

STIHL recommends you use STIHL MotoMix.

If you mix the fuel yourself, use only STIHL two-stroke engine oil or another high-performance engine oil in accordance with JASO FB, JASO FC, JASO FD, ISO-L-EGB, ISO-L-EGC or ISO-L-EGD.

STIHL specifies STIHL HP Ultra two-stroke engine oil or an equivalent high-performance engine oil in order to maintain emission limits over the machine's service life.

- ▶ Make sure that the octane number of the gasoline is at least 90 RON and the ethanol content is not more than 10% (for Brazil: 27%).
- ▶ Make sure the two-stroke engine oil you are using meets requirements.

- ▶ Depending on the desired amount of fuel, determine the correct amounts of two-stroke engine oil and gasoline in a mixing ratio of 1:50. Examples for fuel mixes:
 - 20 ml Two-stroke engine oil, 1 l gasoline
 - 60 ml Two-stroke engine oil, 3 l gasoline
 - 100 ml Two-stroke engine oil, 5 l gasoline
- ▶ Pour two-stroke engine oil into a clean approved fuel canister first and then add gasoline.
- ▶ Stir the fuel before topping up.

8.2 Fueling the brushcutter

- ▶ Shut off the engine.
- ▶ Place your brushcutter on a level surface so that the fuel tank cap faces up.
- ▶ Use a damp cloth to clean the fuel tank cap and the area around it.

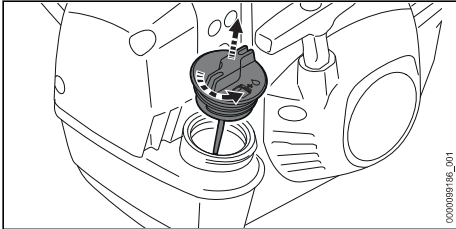

- ▶ Turn the tank cap counterclockwise until it can be removed.
- ▶ Remove the fuel tank cap.

NOTICE

- Exposure to light, direct sunlight and extreme temperatures may accelerate fuel separation or aging. The brushcutter can be damaged if it is used with a fuel mix that has become separated or has aged.
 - ▶ Thoroughly mix the fuel.
 - ▶ Do not top up with fuel stored for more than 30 days (STIHL MotoMix: 5 years).
- ▶ When topping up, ensure that no fuel is spilled and that the fuel level remains at least 15 mm under the edge of the tank.

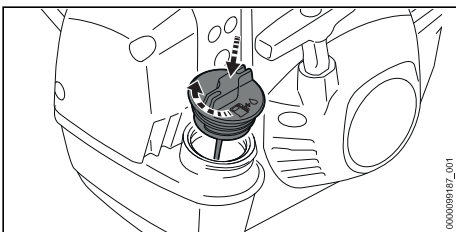

- ▶ Fit the fuel tank cap on the tank opening.

- ▶ Turn the tank cap clockwise and tighten it down firmly by hand. The fuel tank is closed.

9 Starting and Stopping the Engine

9.1 Starting the engine

- ▶ Select the correct starting procedure.
- ▶ Place the trimmer on a level surface so that the cutting attachment does not touch the ground or other objects.
- ▶ Remove the transport guard.

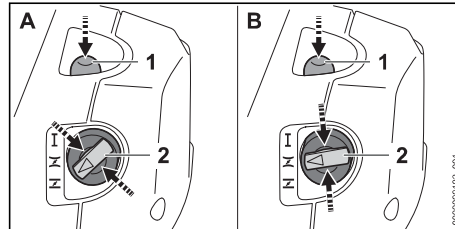

- ▶ Depress the manual fuel pump (1) at least 5 times.

If the following condition is met

- The engine is at ambient temperature.
- ▶ Press the choke lever (2) in at the edge and move it to **Z** position (A).

If any of the following conditions is met:

- The engine has been running for at least 1 minute and has only been shut down for a short break in work.
- The engine sparked in the **Z** position and switched off.
- ▶ Press the choke lever (2) in at the edge and move it to **N** position (B).

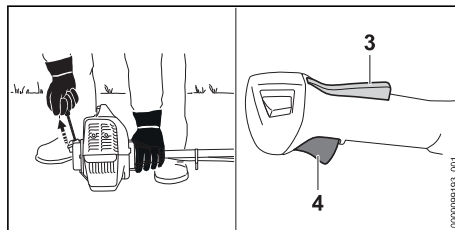

NOTICE

- The brushcutter can be damaged if pressed into the ground with your foot or knee.
 - ▶ Press the brushcutter against the ground with your left hand. Do not stand or kneel on the shaft.

- ▶ Press the brushcutter against the ground with your left hand.
- ▶ Pull the starter grip slowly with your right hand until you feel it engage.
- ▶ Pull the starter grip quickly and allow the starter rope to rewind several times until the engine runs.
- ▶ Briefly press the lockout lever (3) and throttle trigger (4).

The choke control (2) springs to the **I** position. The engine runs at idling speed.

- ▶ **If the engine is cold:** Warm up engine by briefly opening the throttle.
- ▶ **If the cutting attachment rotates when the engine is idling:** Rectify the malfunction. Idle speed adjustment is not correct.
- ▶ **If the engine switches off in the **Z** position or when you open the throttle:** Move the choke lever (2) into the **Z** position and try to start the engine again.
- ▶ **If the engine does not start in the **Z** position:** Move the choke lever (2) to the **Z** position and try again to start the engine.
- ▶ **If the engine is flooded:** Try to start the engine again with the choke lever (2) in the **I** position.

9.2 Shut off the engine

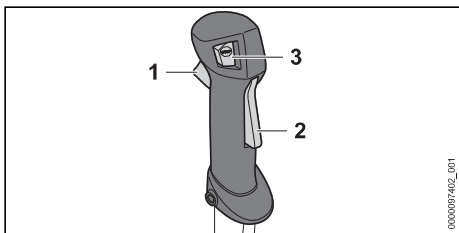

- ▶ Release the throttle trigger (1) and throttle trigger lockout (2). The cutting attachment comes to a standstill.
- ▶ Depress the stop switch (3). The engine stops.
- ▶ **If the engine does not stop:**
 - ▶ Move the choke lever to position **Z**. The engine stops.
 - ▶ Do not use your trimmer and contact a STIHL servicing dealer for assistance. There is a malfunction in the brushcutter.

As long as the stop switch is pressed, the ignition is switched off. After the stop switch has been released again, the ignition is switched on again.

10 Testing the Trimmer

10.1 Checking the controls

Throttle trigger lockout and throttle trigger

- ▶ Shut off the engine.
- ▶ Attempt to pull the trigger without depressing the lockout lever.
- ▶ **If the trigger can be pulled:** Do not use your trimmer and contact your STIHL dealer for assistance. The throttle trigger lockout is defective.
- ▶ Press the throttle trigger lockout and keep pressed.
- ▶ Depress the throttle trigger.
- ▶ Release the throttle trigger and throttle trigger lockout.
- ▶ **If the trigger or trigger lockout is stiff or does not spring back to the idle position:** Do not use your trimmer and contact your STIHL dealer for assistance. Trigger or trigger lockout is faulty.

Throttle cable adjustment

- ▶ Start the engine.
- ▶ Attempt to pull the trigger without depressing the lockout lever.
- ▶ **If the engine accelerates:** Adjust the throttle cable. Throttle cable adjustment is not correct.

Shut off the engine

- ▶ Start the engine.
- ▶ Depress the stop switch. The engine stops.
- ▶ **If the engine does not stop:**
 - ▶ Move the choke lever to the **Z** position. The engine stops.
 - ▶ Do not use your trimmer and contact a STIHL servicing dealer for assistance. There is a malfunction in the brushcutter.

11 Operating the Trimmer

11.1 Setting to winter mode

The carburetor may ice up if the engine is operated at temperatures below +10 °C. The shutter must be set to the winter mode so that the carburetor is additionally heated by warm air from around the engine.

NOTICE

- The engine may overheat if is operated in winter mode at temperatures above +10 °C.
 - ▶ Change setting to summer mode.
- ▶ Shut off the engine.

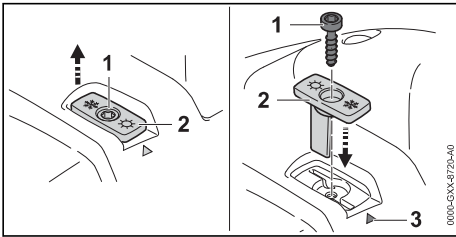

- ▶ Take out the screw (1).
- ▶ Pull out the shutter (2).
- ▶ Hold the shutter (2) so the snowflake points to the mark (3).
- ▶ Insert the shutter (2).
- ▶ Fit the screw (1).

When working at temperatures below -10°C or in powder or drifting snow, a cover plate must also be fitted to the engine housing and an air filter with plastic webbing. The accessories are available from a STIHL servicing dealer.

11.2 Summer Operation

The shutter must be set to summer mode when working at temperatures above +10°C.

- ▶ Shut off the engine.

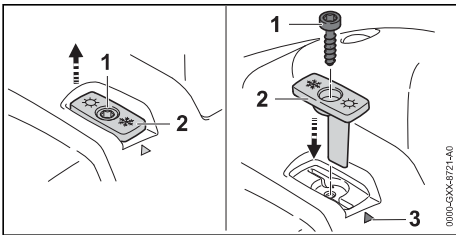

- ▶ Take out the screw (1).
- ▶ Pull out the shutter (2).
- ▶ Hold the shutter (2) so the sun points to the mark (3).
- ▶ Fit the shutter.
- ▶ Fit the screw (1).

11.3 Holding and Controlling the Trimmer

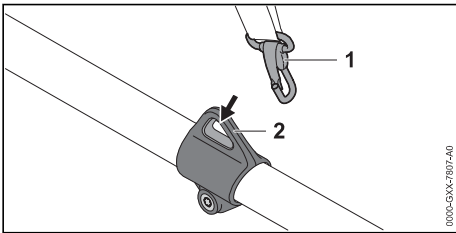

- ▶ Connect the carrying ring (2) to the carabiner (1).

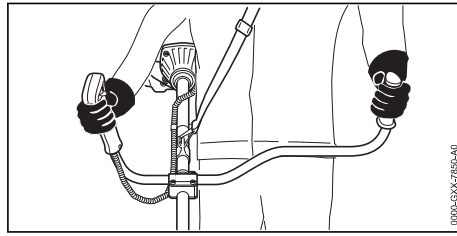

- ▶ Hold the trimmer firmly with your right hand on the control handle – wrap your thumb around the handle.
- ▶ Hold the trimmer firmly with your the left hand on the left handle – wrap your thumb around the handle.

11.4 Mowing

The cutting height is determined by the distance of the cutting attachment from the ground.

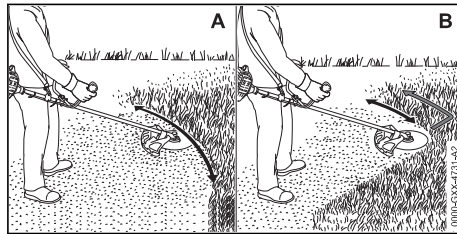

Mowing with a mowing head (A)

- ▶ Swing the brushcutter steadily back and forth in an arc.
- ▶ Move forward slowly in a controlled manner.

Mowing with a grass cutting blade or brush knife (B)

- ▶ Mow with the left-hand side on the metal cutting attachment.
- ▶ Move forward slowly in a controlled manner.

11.5 Thinning with a brush knife

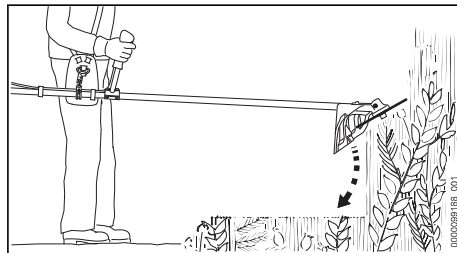

- ▶ Dip the metal cutting attachment into the thicket from above.
- ▶ Do not lift metal cutting tool above waist height.

11.6 Saws with a circular saw blade

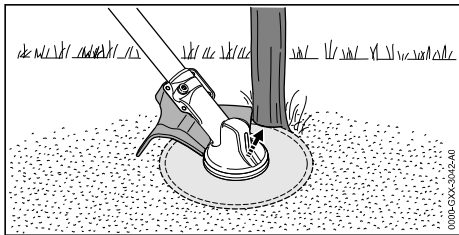

- ▶ Support the left side of the deflector against the stem.
- ▶ Cut through the stem at full speed.
- ▶ A safety distance of at least 2 tree lengths to the next work area.

11.7 Adjusting Nylon Line

11.7.1 Line Feed on AutoCut Mowing Head

- ▶ Tap the rotating mowing head on the ground. About 30 mm of fresh nylon line is advanced. The line limiting blade in the deflector trims the mowing lines to the correct length.

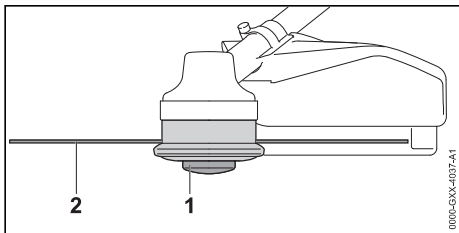

Automatic feed does not operate if the mowing lines are shorter than 25 mm.

- ▶ Shut off the engine.
- ▶ Depress the spool (1) on the mowing head and hold it depressed.
- ▶ Pull out the mowing lines (2).
- ▶ If the mowing lines (2) cannot be pulled out to the required length: Replace the spool (1) or the mowing lines (2). The spool is empty.

11.7.2 Line Feed on SuperCut Mowing Heads

Mowing lines are adjusted automatically. The line limiting blade in the deflector trims the mowing lines to the correct length.

Automatic feed will not take place if the mowing lines are shorter than 40 mm.

- ▶ Shut off the engine.
- ▶ Pull out the mowing lines.
- ▶ If the mowing lines cannot be pulled out to required length: Replace nylon line. The spool is empty.

12 After Finishing Work

12.1 When Work is Finished

- ▶ Shut off the engine.
- ▶ Allow trimmer to cool down.
- ▶ If the brushcutter is wet: Allow the brushcutter to dry.
- ▶ Clean the brushcutter.
- ▶ Clean the deflector.
- ▶ Clean the cutting attachment.
- ▶ If a metal cutting attachment is mounted: Fit the matching transport guard.

13 Transporting

13.1 Transporting the Trimmer

- ▶ Shut off the engine.
- ▶ If a metal cutting attachment is mounted: Fit the matching transport guard.

Carrying the trimmer

- ▶ Carry the trimmer properly balanced by the drive tube with the cutting attachment behind you.

Transporting the trimmer in a vehicle

- ▶ Secure the trimmer to prevent turnover and movement.

14 Storing

14.1 Storing the Brushcutter

- ▶ Shut off the engine.
- ▶ If a metal cutting attachment is mounted: Fit the matching transport guard.

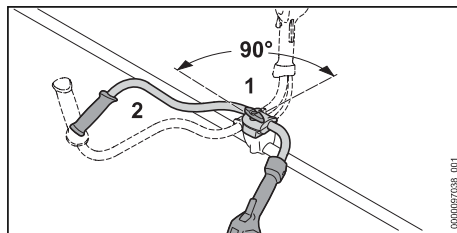

- ▶ Loosen the wing screw (1) and unscrew it until the handlebar (2) can be rotated.
- ▶ Turn the handlebar (2) clockwise through 90° and fold it down.

- ▶ Tighten down the wing screw (1) firmly.
- ▶ Ensure that the following conditions are met when storing the brushcutter:
 - The brushcutter is out of the reach of children.
 - The brushcutter is clean and dry.
- ▶ If you store the trimmer for more than 30 days:
 - ▶ Remove the cutting attachment.
 - ▶ Open the fuel tank cap.
 - ▶ Drain the fuel tank.
 - ▶ Close the fuel tank.
 - ▶ If a manual fuel pump is fitted: Press the manual fuel pump 5 times.
 - ▶ Start the engine and run it at idling speed until it stops.

15 Cleaning

15.1 Cleaning the Trimmer

- ▶ Shut off the engine.
- ▶ Allow trimmer to cool down.
- ▶ Clean the trimmer with a damp cloth or STIHL resin solvent.
- ▶ Clean cooling air slots with a soft brush.

15.2 Cleaning the Deflector and Cutting Attachment

- ▶ Shut off the engine.
- ▶ Clean the deflector and cutting attachment with a damp cloth or a soft brush.

16 Maintenance

16.1 Maintenance Intervals

The maintenance intervals are dependent on the environmental and operating conditions. STIHL recommends the following maintenance intervals:

After every 25 hours of operation

- ▶ Lubricate the gearbox.

After every 100 hours of operation

- ▶ Install a new spark plug.

Monthly

- ▶ Have fuel tank cleaned by a STIHL servicing dealer.
- ▶ Have pickup body (filter) in fuel tank cleaned by a STIHL servicing dealer.

Every 12 months

- ▶ Have pickup body (filter) in fuel tank replaced by a STIHL servicing dealer.

16.2 Lubricating the gearbox

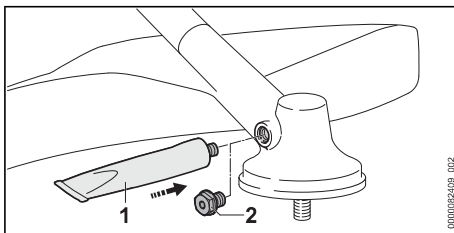

- ▶ Remove screw plug (2).
- ▶ If no grease can be seen on the end of the screw plug (2):
 - ▶ Screw in the tube of STIHL gear lubricant (1).
 - ▶ Squeeze 5 g of STIHL gear grease into the gear housing.
 - ▶ Unscrew the tube of STIHL gear lubricant (1).
 - ▶ Refit and firmly tighten the screw plug (2).
 - ▶ Run the brushcutter for 1 minute without load. The STIHL gear lubricant is evenly distributed.

16.3 Sharpening and Balancing a Metal Cutting Attachment

Correctly sharpening and balancing metal cutting attachments requires a lot of practice.

STIHL recommends you have metal cutting attachments resharpened and balanced by a STIHL servicing dealer.

- ▶ Sharpen the metal cutting attachment as described in the instructions and on the packaging supplied with the cutting attachment you are using.

17 Repairing

17.1 Repairing the Trimmer and Cutting Attachment

The trimmer and cutting attachment cannot be repaired by the user.

- ▶ If the trimmer or cutting attachment is damaged: Do not use your trimmer or cutting attachment and contact your STIHL servicing dealer.

18 Troubleshooting

18.1 Troubleshooting the Brushcutter

Most problems can be attributed to the same cause.

- ▶ Carry out the following measures:
 - ▶ Replace the air filter.
 - ▶ Clean or replace the spark plug.
 - ▶ Adjust the idle speed.
 - ▶ Adjust for winter or summer operation.
- ▶ If the problem continues: Carry out the measured listed below.

Fault	Cause	Remedy
The engine does not start.	There is not enough fuel in the fuel tank.	▶ Prepare fuel mix and refuel the trimmer.
	The engine has flooded.	▶ Start the engine with the choke lever in the I position.
	The carburetor is too hot.	▶ Allow trimmer to cool down. ▶ Depress the manual fuel pump at least 10 times before starting the engine.
	The carburetor has iced up.	▶ Allow brushcutter to warm up to +10°C.
The engine idles erratically.	The carburetor has iced up.	▶ Allow brushcutter to warm up to +10°C.
The engine stops while idling.	The carburetor has iced up.	▶ Allow brushcutter to warm up to +10°C.
Cutting attachment runs while engine is idling.	Throttle cable adjustment is not correct.	▶ Adjust the throttle cable.
	Idle speed adjustment is not correct.	▶ Adjust the idle speed.
The engine does not reach maximum speed.	Throttle cable adjustment is not correct.	▶ Adjust the throttle cable.
The engine switches off although there is still fuel in the fuel tank.	The pickup body is not located in the right place.	▶ Contact a STIHL authorized dealer.

18.2 Replacing air filter

The air filter cannot be cleaned. The air filter must be replaced if it is damaged or there is a loss of engine power.

- ▶ Shut off the engine.
- ▶ Move the choke lever to the **Z** position.

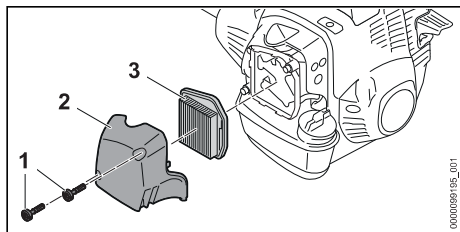

- ▶ Take out the screws (1) and remove the filter cover (2).

- ▶ Clean the area around the air filter (3) with a damp cloth or a soft brush.
- ▶ Take out the air filter (3).
- ▶ Install the new air filter (3).
- ▶ Fit the filter cover (2).
- ▶ Insert screws (1) and tighten.

18.3 Cleaning the Spark Plug

- ▶ Shut off the engine.
- ▶ Allow trimmer to cool down.

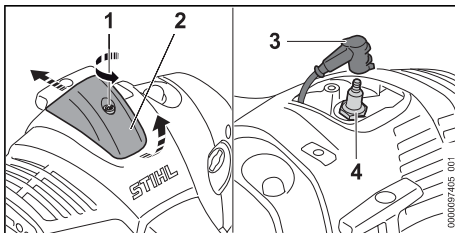

- ▶ Turn screw (1) counterclockwise.
- ▶ Lift the cover (2) and push it backwards.
- ▶ Pull off the spark plug boot (3).
- ▶ If the area around the spark plug (4) is soiled: Clean the spark plug (4) with a cloth.
- ▶ Unscrew the spark plug (4).
- ▶ Clean the spark plug (4) with a cloth.
- ▶ If the spark plug (4) is corroded: Install a new spark plug (4).
- ▶ Insert and tighten down the spark plug (4) firmly.
- ▶ Press the spark plug boot (3) firmly home.
- ▶ Install cover (2) and tighten screw (1).

18.4 Adjust idle speed

- ▶ Start the engine.
- ▶ Warm up the engine by repeatedly opening and closing the throttle for about 1 minute.

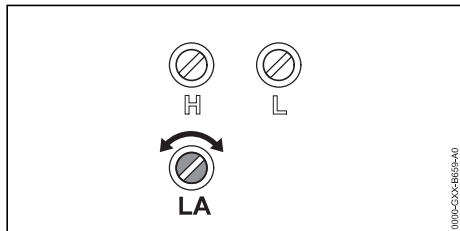

The engine stops while idling

- ▶ Turn the idle speed screw (LA) clockwise until the engine runs smoothly.

Cutting attachment rotates when engine is idling

- ▶ Turn the idle speed screw (LA) counterclockwise until the cutting attachment stops rotating.

18.5 Adjusting the Throttle Cable

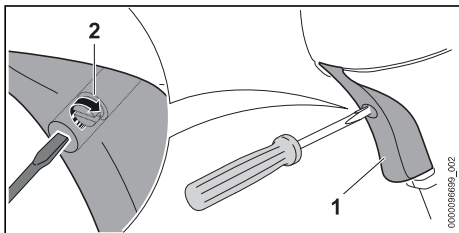

- ▶ Press the throttle trigger (1) and keep pressed.
- ▶ Turn screw (2) clockwise until resistance is felt.
- ▶ Turn the screw (2) clockwise through another half-turn.

19 Specifications

19.1 STIHL FS 240 Brushcutter

- Displacement: 37.7 cm³
- Engine power according to ISO 8893: 1.7 kW (2.3 hp) at 8,500 rpm
- Idle speed : 2,800 rpm
- Max. output shaft speed: 9,360 rpm
- Approved spark plug: NGK CMR6H from STIHL
- Electrode gap of the spark plug: 0.5 mm
- Weight with empty fuel tank and without cutting attachment and deflector:
 - FS 240: 6.9 kg
 - FS 240 C: 7.1 kg
- Length without cutting attachment: 1805 mm
- Max. fuel tank capacity: 750 cm³ (0.75 l)

19.2 Sound Values and Vibration Values

The K-value for the sound pressure levels is 2 dB(A). The K-value for the sound power levels is 2 dB(A). The K-value for vibration level is 2 m/s².

Using with a mowing head

- Sound pressure level L_{pA} measured according to ISO 22868: 100 dB(A).
- Sound power level L_w measured according to ISO 22868: 108 dB(A)
- Vibration level a_{hv} measured according to ISO 22867:
 - Control handle: 4.3 m/s².
 - Left handle: 4.4 m/s².

Using with a metal cutting attachment

- Sound pressure level L_{pA} measured according to ISO 22868: 99 dB(A).
- Sound power level L_w measured according to ISO 22868: 110 dB(A)
- Vibration level a_{hv} measured according to ISO 22867:
 - Control handle: 4.0 m/s².
 - Left handle: 4.7 m/s².

For information on compliance with Employers' Vibration Directive 2002/44/EC, see www.stihl.com/vib.

19.3 REACH

REACH is an EC regulation and stands for the Registration, Evaluation, Authorisation and Restriction of Chemical substances.

For information on compliance with the REACH regulation see www.stihl.com/reach.

19.4 Exhaust Emissions

The CO₂ value measured in the EU type approval procedure is specified at www.stihl.com/co2 in the product-specific technical data.

The measured CO₂ value was determined on a representative engine in accordance with a standardised test procedure under laboratory

conditions and does not represent either an explicit or implied guarantee of the performance of a specific engine.

The applicable exhaust emission requirements are fulfilled by the intended usage and maintenance described in this instruction manual. The type approval expires if the engine is modified in any way.

20 Combinations of Cutting Attachments, Deflectors and Carrying Systems

20.1 Combinations of Cutting Attachments, Deflectors and Carrying Systems

Cutting attachment	Deflector	Carrying System
<ul style="list-style-type: none"> – AutoCut 25-2 mowing head – AutoCut 27-2 mowing head – AutoCut 36-2 mowing head – AutoCut C 26-2 mowing head – DuroCut 20-2 mowing head – PolyCut 18-2 mowing head – PolyCut 28-2 mowing head – SuperCut 20-2 mowing head – TrimCut C 32-2 mowing head 	<ul style="list-style-type: none"> – Guard for mowing heads – Universal deflector with skirt and line limiting blade 	<ul style="list-style-type: none"> – Shoulder strap – Full harness with quick release system
<ul style="list-style-type: none"> – Grass cutting blade 230-2 (230 mm dia.) – Grass cutting blade 230-4 (230 mm dia.) – Grass cutting blade 230-8 (230 mm dia.) – 250-32 Grass cutting blade (250 mm dia.) – 250-40 Special grass cutting blade (250 mm dia.) – 260-2 Grass cutting blade (260 mm dia.) 	<ul style="list-style-type: none"> – Universal deflector without skirt 	<ul style="list-style-type: none"> – Shoulder strap – Full harness with quick release system
<ul style="list-style-type: none"> – Brush knife 250-3 (Ø 250 mm) 	<ul style="list-style-type: none"> – Universal deflector without skirt 	<ul style="list-style-type: none"> – Shoulder strap – Full harness with quick release system
<ul style="list-style-type: none"> – 200-80 circular saw blade, scratcher tooth (200 mm dia.) – 220-22 circular saw blade, chisel tooth (4112) (200 mm dia.) – 220-22 HP circular saw blade, chisel tooth (4001) (200 mm dia.) 	<ul style="list-style-type: none"> – Limit stop 	<ul style="list-style-type: none"> – Full harness with quick release system

21 Approved Power Tool Attachments

21.1 Approved Power Tool Attachments

Power tool attachment	Use
BF	Soil cultivator

22 Spare Parts and Accessories

22.1 Spare parts and accessories

STIHL  These symbols indicate original STIHL spare parts and original STIHL accessories.

STIHL recommends the use of original STIHL spare parts and accessories.

Despite ongoing market observation, STIHL is unable to judge the reliability, safety and suitability of other manufacturers' spare parts and

accessories; accordingly, STIHL cannot warrant for the use of those parts.

Original STIHL spare parts and original STIHL accessories are available from STIHL dealers.

23 Disposal

23.1 Disposing of the Brushcutter

Contact the local authorities or your STIHL dealer for information on disposal.

Improper disposal can be harmful to health and pollute the environment.

- ▶ Take STIHL products including packaging to a suitable collection point for recycling in accordance with local regulations.
- ▶ Do not dispose with domestic waste.

24 EC Declaration of Conformity

24.1 STIHL FS 240 Brushcutter

ANDREAS STIHL AG & Co. KG
Badstraße 115
D-71336 Waiblingen

Germany

declare under our sole responsibility that

- Category: Brushcutter
- Manufacturer's brand: STIHL
- Type: FS 240
- Serial number: 4147

conforms to the relevant provisions of Directives 2011/65/EU, 2006/42/EC, 2014/30/EU and 2000/14/EC and has been developed and manufactured in compliance with the following standards in the versions valid on the date of production: EN ISO 11806-1, EN 55012 and EN 61000-6-1.

The measured and guaranteed sound power levels were determined according to Directive 2000/14/EC, Annex V.

- Measured sound power level: 113 dB(A)
- Guaranteed sound power level: 115 dB(A)

The technical documents are stored at ANDREAS STIHL AG & Co. KG Produktzulassung.

The year of manufacture, country of manufacture and serial number are specified on the rating plate of the brushcutter.

Waiblingen, 01.08.2022

ANDREAS STIHL AG & Co. KG

0458-860-0101-A

pp 

Robert Olma, Vice President, Regulatory Affairs & Global Governmental Relations

25 UKCA Declaration of Conformity

25.1 STIHL FS 240 Brushcutter

**UK
CA**

ANDREAS STIHL AG & Co. KG
Badstraße 115
D-71336 Waiblingen

Germany

declare under our sole responsibility that

- Category: Brushcutter
- Manufacturer's brand: STIHL
- Type: FS 240
- Serial number: 4147

conforms to the relevant provisions of UK regulations The Restriction of the Use of Certain Hazardous Substances in Electrical and Electronic Equipment Regulations 2012, Supply of Machinery (Safety) Regulations 2008, Electromagnetic Compatibility Regulations 2016 and Noise Emission in the Environment by Equipment for use Outdoors Regulations 2001 and has been manufactured in compliance with the following standards in the versions valid on the date of production: EN ISO 11806-1, EN 55012, and EN 61000-6-1.

The measured and the guaranteed sound power level have been determined in accordance with UK regulation Noise Emission in the Environment by Equipment for use Outdoors Regulations 2001, Schedule 8.

- Measured sound power level: 113 dB(A)
- Guaranteed sound power level: 115 dB(A)

The technical documents are stored at ANDREAS STIHL AG & Co. KG.

The year of manufacture, country of manufacture and serial number are specified on the rating plate of the brushcutter.

Waiblingen, 01.08.2022

ANDREAS STIHL AG & Co. KG

pp

Robert Olma, Vice President, Regulatory Affairs
& Global Governmental Relations

www.stihl.com



0458-860-0101-A



0458-860-0101-A