

BGA 250.0

STIHL



| | |
|---------|--------------------|
| 2 - 20 | Gebrauchsanleitung |
| 20 - 36 | Instruction Manual |
| 36 - 56 | Notice d'emploi |
| 56 - 73 | Istruzioni d'uso |
| 73 - 91 | Handleiding |



blasen von Unrat in der Nähe von festen Objekten wie Bäumen, Autos oder Wänden, an denen der Unrat abprallen kann. Weggeschleuderte Teile können das Risiko von Verletzungen erhöhen.

- g) **Verwenden Sie das Blasgerät nicht, um Brennendes oder Rauchendes, wie z. B. Zigaretten, Streichhölzer oder Asche wegzublase**n. Diese Zündquellen können das Brandrisiko erhöhen.
- h) **Berühren Sie nicht den sich noch drehenden Ventilator. Schalten Sie das Blasgerät aus, warten Sie bis zum Stillstand des Ventilators, bevor Sie ein Teil entfernen, das den Zugang zum Ventilator freigibt.** Dies verringert das Risiko einer Verletzung durch bewegte Teile.
- i) **Stellen Sie sicher, dass der Schalter ausgeschaltet ist, bevor Sie eingeklemmtes Material entfernen oder das Blasgerät warten.** Ein unerwarteter Betrieb des Blasgeräts beim Entfernen von eingeklemmtem Material oder bei der Wartung kann das Risiko von Verletzungen erhöhen.

Contents

| | | |
|----|---|----|
| 1 | Introduction..... | 20 |
| 2 | Guide to Using this Manual..... | 20 |
| 3 | Overview..... | 21 |
| 4 | Safety Precautions..... | 22 |
| 5 | Preparing the Blower for Operation..... | 26 |
| 6 | Charging the Battery, LEDs..... | 26 |
| 7 | Activating and Deactivating Bluetooth® Radio Interface..... | 27 |
| 8 | Assembling the Blower..... | 27 |
| 9 | Removing and Fitting the Battery..... | 27 |
| 10 | Switching the Blower On/Off..... | 28 |
| 11 | Testing the Blower and Battery..... | 28 |
| 12 | Operating the Blower..... | 28 |
| 13 | After Finishing Work..... | 29 |
| 14 | Transporting..... | 29 |
| 15 | Storing..... | 30 |
| 16 | Cleaning..... | 30 |
| 17 | Maintenance and Repairs..... | 30 |
| 18 | Troubleshooting..... | 30 |
| 19 | Specifications..... | 31 |
| 20 | Spare Parts and Accessories..... | 32 |
| 21 | Disposal..... | 33 |
| 22 | EC Declaration of Conformity..... | 33 |
| 23 | UKCA Declaration of Conformity..... | 33 |
| 24 | Addresses..... | 34 |

25 General Power Tool Safety Warnings.....34

1 Introduction

Dear Customer,

Thank you for choosing STIHL. We develop and manufacture our quality products to meet our customers' requirements. The products are designed for reliability even under extreme conditions.

STIHL also stands for premium service quality. Our dealers guarantee competent advice and instruction as well as comprehensive service support.

STIHL expressly commit themselves to a sustainable and responsible handling of natural resources. This user manual is intended to help you use your STIHL product safely and in an environmentally friendly manner over a long service life.

We thank you for your confidence in us and hope you will enjoy working with your STIHL product.



Dr. Nikolas Stihl

IMPORTANT! READ BEFORE USING AND KEEP IN A SAFE PLACE FOR REFERENCE.

2 Guide to Using this Manual

2.1 Applicable documents

The local safety regulations apply.

► In addition to this User Manual, you should also read, understand and retain the following documents:

- User Manual for STIHL AR battery
- User Manual for "AP belt bag with connecting cable"
- Safety instructions and precautions for STIHL AP battery
- User Manual for STIHL AL 101, 301, 301-4, 501 chargers
- Safety information for STIHL batteries and products with built-in battery:
www.stihl.com/safety-data-sheets

For further information on STIHL connected, compatible products and FAQs, please visit www.connect.stihl.com or available from a STIHL authorized dealer.

The Bluetooth® word mark and logos are registered trademarks owned by Bluetooth SIG, Inc. These word marks and logos are used by STIHL under license.

Batteries with  are equipped with a Bluetooth® radio interface. Local operating restrictions (in aircraft or hospitals, for example) must be complied with.

2.2 Symbols used with warnings in the text

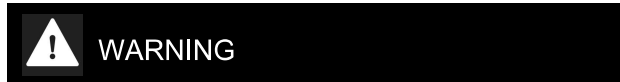

- This symbol indicates dangers that can cause serious injuries or death.
 - ▶ The measures indicated can avoid serious injuries or death.



- This symbol indicates dangers that can cause damage to property.
 - ▶ The measures indicated can avoid damage to property.

2.3 Symbols in Text

 This symbol refers to a chapter in this instruction manual.

3 Overview

3.1 Blower

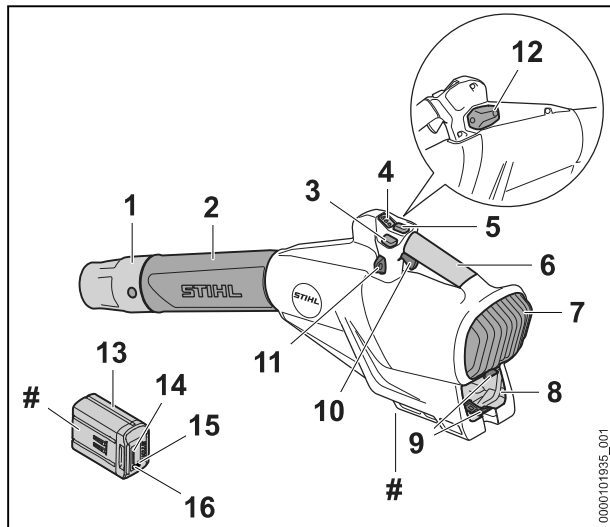

- 1 Nozzle**
The nozzle directs and concentrates the air stream.
- 2 Blower tube**
The blower tube directs the air stream.
- 3 Power lock button**
The power lock button locks the current blowing force.
- 4 LEDs**
The LEDs indicate the selected power level.
- 5 Power setting button**
The power setting button is used to select the power level.
- 6 Control handle**
The control handle is used to operate, control and carry the blower.
- 7 Shield**
The shield protects the user from moving parts inside the blower.
- 8 Battery compartment**
The battery compartment holds the battery.
- 9 Locking lever**
The locking lever holds the battery in the battery compartment.
- 10 Trigger**
The trigger switches the blower on and off.
- 11 Carrying ring**
The carrying ring is for attaching a carrying system.
- 12 Cover²**
The cover is the placeholder for a Smart Connector 2 A.
- 13 Battery**
The battery supplies the blower with energy.
- 14 LEDs**
The LEDs indicate the state of charge of the battery and any faults.
- 15 Button**
The pushbutton activates the LEDs on the battery. The pushbutton activates and deactivates the Bluetooth® interface (if available).
- 16 "BLUETOOTH®" LED (only for batteries with )**
The LED indicates the activation and deactivation of the Bluetooth® interface.

²The cover is part of the motor housing. Only remove the cover to install a Smart Connector 2 A and store it safely for later re-installation. Always use the blower with the cover or Smart Connector 2 A installed.

Rating plate with machine number

3.2 Symbols

The symbols may appear on the blower and the battery. Their meaning is as follows:

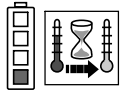

1 LED lights up red. The battery is too warm or too cold.

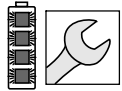

4 LEDs flash red. There is an error in the battery.



Guaranteed sound power level in accordance with Directive 2000/14/EC in dB(A) for the purpose of comparing the sound emissions of products.



Recharge this battery with a STIHL charger. The admissible chargers are listed in these safety instructions.



The battery is equipped with a Bluetooth® radio interface and can be paired with the STIHL connected app.



The information next to the symbol indicates the energy content of the battery according to the cell manufacturer's specification. The energy content available in operation is lower.



Do not dispose of the product with domestic waste.

4 Safety Precautions

4.1 Warning symbols

The warning symbols on the blower or the battery have the following meanings:



Observe safety notices and take the necessary precautions.



Read and understand the User Manual and keep it in a safe place for reference.



Wear safety glasses.



Observe the safety advice concerning flying objects and associated measures.



Secure long hair so that it cannot be pulled into the blower.



Remove the battery during work interruptions, transport, storage, maintenance or repair.



Maintain a safe distance.



Protect the battery against heat and fire.



Do not immerse the battery in liquids.

4.2 Intended Use

The STIHL BGA 250.0 blower is designed for blowing leaves, grass, paper and similar materials.

The blower can be used in the rain.

The blower is supplied with energy by a STIHL AP battery or a STIHL AR battery.

The battery with  in combination with the STIHL connected app enables customization and the transfer of information to the battery based on Bluetooth® technology.

⚠ WARNING

- Batteries not approved by STIHL for the blower can cause fires and explosions. Persons may be seriously or fatally injured, and property may be damaged.
 - ▶ Operate the blower with a STIHL AP battery or a STIHL AR battery.
- Using the blower or battery other than for its intended use can result in serious injuries or death and damage to property.
 - ▶ Always use the blower as described in this user manual.
 - ▶ Use the battery as described in this User Manual, the STIHL AR battery User Manual, the STIHL connected app and at www.connect.stihl.com.

4.3 Requirements concerning the user

⚠ WARNING

- Users who have not received instruction are not aware of and cannot assess the dangers of the blower and the battery. The user or other people may be seriously injured or killed.
 - ▶ Read the Instruction Manual, make sure you have understood it and keep it in a safe place for reference.



- ▶ If allowing another person to use the blower or the battery: Give them the Instruction Manual as well.
- ▶ Make sure that the user fulfills the following requirements:
 - The user is rested.
 - The user is physically, sensorially and mentally able to operate the blower and the battery and to work with them. If the user is able to operate the equipment but has physical, sensory or mental restrictions, the user may only work with the equipment under the supervision of or after receiving instruction from a responsible person.
 - The user can recognize and assess the hazards of the blower and battery.
 - The user is an adult, or is being trained in an occupation under supervision according to national regulations.
 - The user has received instruction from a STIHL servicing dealer or other expert before operating the blower for the first time.
 - The user is not under the influence of alcohol, medicines or drugs.
- ▶ If in any doubt: Contact a STIHL servicing dealer.

4.4 Clothing and Equipment

⚠ WARNING

- Long hair can be sucked into the blower during operation. This can result in serious injuries.



- ▶ Tie up long hair so that it is above shoulder level.

- Objects can be thrown through the air at high speed during operation. This can result in personal injury.



- ▶ Wear close-fitting safety glasses. Suitable glasses that have been tested and labeled in accordance with EN 166 or national standards are available from retailers.

- ▶ Wear long trousers.
- Dust can be whipped up during operation: Whipped up dust can damage the respiratory passages and cause allergic reactions.
 - ▶ If dust is generated: Wear a dust respirator mask.
- Unsuitable clothing can snag on wood, brush or the blower. Not wearing suitable clothing may result in serious injury.
 - ▶ Wear snug-fitting clothing.

- ▶ Do not wear a scarf or jewelry.
- Wearing unsuitable footwear may cause you to slip or stumble. This can result in personal injury.
 - ▶ Wear sturdy enclosed footwear with non-slip soles.

4.5 Work Area and Surroundings

4.5.1 Blower

⚠ WARNING

- Bystanders, children and animals are not aware of the dangers of the blower and objects being thrown into the air and cannot assess them. This may result in serious injury to bystanders, children and animals and damage to property.

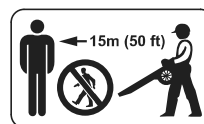

- ▶ Do not allow bystanders, children or animals within 15 meters of the work area.

- ▶ Maintain a clearance of 15 meters from objects.
- ▶ Do not leave the blower unattended.
- ▶ Ensure that children cannot play with the blower.
- Electrical components of the blower can produce sparks. Sparks may cause fires and explosions in highly flammable or explosive environments. Persons may be seriously or fatally injured, and property may be damaged.
 - ▶ Do not work in a highly flammable or explosive environment.

4.5.2 Battery

⚠ WARNING

- Bystanders, children and animals cannot recognize or assess the dangers of the battery. Bystanders, children and animals may be seriously injured.
 - ▶ Keep bystanders, children and animals away from the work area.
 - ▶ Do not leave the battery unattended.
 - ▶ Make sure that children cannot play with the battery.
- The battery is not protected against all ambient conditions. If the battery is exposed to certain ambient conditions, the battery may catch fire, explode or be irreparably damaged. This may result in serious injury to people and damage to property.



- ▶ Protect battery from heat and fire.
- ▶ Do not throw the battery into a fire.

- ▶ Do not charge, use and store the battery outside of the specified temperature limits,  19.3.



- ▶ Do not immerse the battery in liquids.
- ▶ Keep battery away from small metal parts.
- ▶ Do not expose the battery to high pressure.
- ▶ Do not expose the battery to microwaves.
- ▶ Protect the battery from chemicals and salts.

4.6 Safe Condition

4.6.1 Blower

The blower is in a safe condition if the following conditions are fulfilled:

- The blower is undamaged.
- The blower is clean.
- The controls function properly and have not been modified.
- Original STIHL accessories are fitted.
- The accessories are correctly installed.

WARNING

- If not in safe condition, components may no longer operate correctly, and safety devices may be rendered ineffective. There is a risk of serious or fatal injury.
 - ▶ Never use a damaged blower.
 - ▶ If the blower is dirty: Clean the blower.
 - ▶ If the battery compartment is moist or wet: Allow the battery compartment to dry.
 - ▶ Do not modify the blower.
 - ▶ If the controls do not function properly: Do not work with the blower.
 - ▶ Fit original STIHL accessories designed for this blower model.
 - ▶ Install accessories as described in this User Manual or in the User Manual for the accessories.
 - ▶ Do not insert objects into the openings in the blower.
 - ▶ Replace worn or damaged labels.
 - ▶ If you are unsure: Contact a STIHL authorized dealer.

4.6.2 Battery

The battery is in a safe condition if the following points are observed:

- Battery is undamaged.
- The battery is clean and dry.
- Battery functions properly and has not been modified.

WARNING

- A battery that is not in a safe condition cannot operate safely. Persons may be seriously injured.
 - ▶ Never work with a damaged battery.
 - ▶ Never attempt to charge a damaged or defective battery.
 - ▶ If the battery is dirty: Clean the battery.
 - ▶ If the battery is wet or damp: Allow the battery to dry,  19.4.
 - ▶ Never attempt to modify the battery.
 - ▶ Never insert objects in the battery's openings.
 - ▶ Never bridge the battery's contacts with metallic objects (short circuit).
 - ▶ Do not open the battery.
 - ▶ Replace worn or damaged labels.
- Fluid may leak from a damaged battery. If that liquid comes into contact with the skin or eyes, the skin or eyes may be irritated.
 - ▶ Avoid contact with the liquid.
 - ▶ If skin contact occurs: Wash affected areas of skin with plenty of water and soap.
 - ▶ In the event of contact with eyes: Rinse eyes with plenty of water for at least 15 minutes and consult a doctor.
- A damaged or defective battery may smell unusual, emit smoke or burn. Persons may be seriously or fatally injured, and property may be damaged.
 - ▶ If the battery smells unusual or emits smoke: do not use the battery and keep it away from combustible substances.
 - ▶ If the battery catches fire: Attempt to extinguish the battery with a fire extinguisher or water.

4.7 Operation

WARNING

- In certain situations, the user may no longer be able to concentrate on their work. This may result in the user stumbling, falling and suffering serious injury.
 - ▶ Work calmly and methodically.
 - ▶ If light and visibility are poor: Do not work with the blower.
 - ▶ Do not use the blower on your own.
 - ▶ Do not work above shoulder height.
 - ▶ Watch out for obstacles.
 - ▶ Work standing on the ground and keep your balance. If you have to work at a height: Use a mobile elevating work platform or secure scaffolding.
 - ▶ If you start feeling fatigue: Take a break.

- ▶ Blow in direction of the wind.
- Objects can be thrown at high speed during operation. This can result in injuries to persons and animals and damage to property.



- ▶ Do not direct air blast towards people, animals or objects.
- If the blower starts behaving differently or in an unusual way while operating, the blower may be in an unsafe condition. This may result in serious injury to people and damage to property.
 - ▶ Stop working, remove the battery and consult a STIHL servicing dealer.
- Vibrations may occur during blower operation.
 - ▶ Take breaks.
 - ▶ If signs of a circulatory disorder occur: Consult a doctor.
- The dust whipped up may cause the blower to be electrostatically charged. In certain conditions (e.g. dry environment) the blower may discharge suddenly and emit sparks. Sparks may cause fires and explosions in highly flammable or explosive environments. Persons may be seriously or fatally injured, and property may be damaged.
 - ▶ Do not work in a highly flammable or explosive environment.
- In an emergency, the user may start to panic and forget to take off the carrying system. This may result in serious injury to the user.
 - ▶ Practice taking off the carrying system.
 - ▶ Do not combine several carrying systems with one another.

4.8 Transporting

4.8.1 Blower

⚠ WARNING

- The blower can turn over or move while being transported. This may result in personal injuries and damage to property.



- ▶ Remove the battery.
- ▶ Secure the blower with lashing straps or a net to prevent it turning over and moving.

4.8.2 Battery

⚠ WARNING

- The battery is not protected against all ambient conditions. The battery may be damaged if

it is exposed to certain ambient conditions, and damage to property may occur.

- ▶ Never transport a damaged battery.
- The battery may turn over or shift during transport. This may result in injury to people and damage to property.
 - ▶ Pack the battery in packaging in such a way that it cannot move.
 - ▶ Secure the packaging so that it cannot move.

4.9 Storing

4.9.1 Blower

⚠ WARNING

- Children are not aware of and cannot assess the dangers of a blower and can be seriously injured.



- ▶ Remove the battery.
- ▶ Store the blower out of the reach of children.
- Dampness can corrode the electrical contacts on the blower and metal components. The blower may be damaged.



- ▶ Remove the battery.
- ▶ Store the blower in a clean and dry condition.

4.9.2 Battery

⚠ WARNING

- Children are not aware of and cannot assess the dangers of the battery. Children may be seriously injured.
 - ▶ Store the battery out of the reach of children.
- The battery is not protected against all ambient conditions. If the battery is exposed to certain ambient conditions, the battery may be irreparably damaged.
 - ▶ Store the battery in a clean and dry condition.
 - ▶ Store the battery in an enclosed space.
 - ▶ Store the battery separately from the blower.
 - ▶ If the battery is stored in the charger, disconnect the mains plug and store the battery at a state of charge between 40% and 60% (2 lit green LEDs).

- ▶ Do not store the battery outside of the specified temperature limits,  19.3.

4.10 Cleaning, Maintenance and Repair

WARNING

- If the battery is inserted when carrying out cleaning, servicing or repairs, it is possible for the blower to be switched on unintentionally. This may result in serious injury to people and damage to property.









- ▶ Remove the battery.

- Harsh detergents, cleaning with a water jet or sharp objects can damage the blower and the battery. If the blower or battery are not cleaned as described in this user manual, components may no longer function properly and safety devices may be rendered inoperative. People may be seriously injured.
 - ▶ Clean the blower and battery as described in this user manual.
- If the blower or battery are not properly serviced or repaired, components may no longer function properly and safety devices may be rendered inoperative. Persons may be seriously injured or killed.
 - ▶ Do not attempt to service or repair the blower or the battery yourself.
 - ▶ If the blower or the battery require servicing or repairs: Contact a STIHL dealer for assistance.

5 Preparing the Blower for Operation

5.1 Preparing the blower for operation

The following steps must be performed before commencing work:

- ▶ Ensure that the following components are in a safe condition:
 - Blower,  4.6.1.
 - Battery,  4.6.2.
- ▶ Check the battery,  11.2.
- ▶ Fully charge battery as described in the User Manual for the STIHL AL 101, 301, 301-4, 501 chargers.
- ▶ Clean blower,  16.
- ▶ Attach nozzle,  8.1.
- ▶ Check the controls,  11.1.

- ▶ If it is not possible to carry out these steps: Do not use the blower and instead contact a STIHL authorized dealer.

5.2 Connecting a battery with Bluetooth® radio interface with the STIHL connected app

- ▶ Activate the Bluetooth® radio interface on the mobile device.
- ▶ Activating the Bluetooth® radio interface on the battery,  7.1.
- ▶ Download the STIHL connected app to the mobile device from the App Store and create an account.
- ▶ Open and sign in to the STIHL connected app.
- ▶ Add the battery in the STIHL connected app and follow the instructions on the screen.

For contacts and other information, please visit <https://support.stihl.com> or see the STIHL connected app.

The STIHL connected app is available internationally.

6 Charging the Battery, LEDs

6.1 Charging the battery

The charging time depends on various factors, e.g. the battery temperature or the ambient temperature. For optimal performance, note the recommended temperature ranges,  19.4. The actual charging time may vary from the charging time indicated. The charging time is indicated at www.stihl.com/charging-times.

- ▶ Recharge the battery as described in the User Manual for STIHL AL 101, 301, 301-4, 501 chargers.

6.2 Displaying the charge level

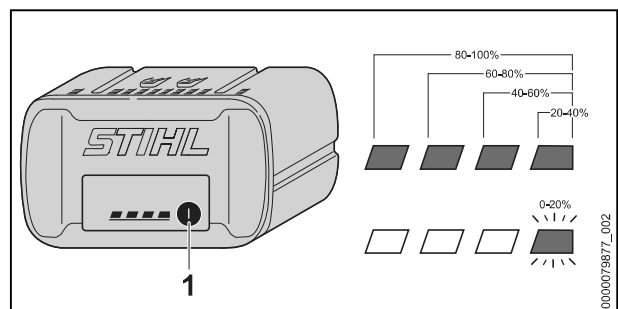

- ▶ Press the button (1). The LEDs light up green for about 5 seconds and indicate the state of charge.
- ▶ If the LED on the right flashes green: Charge the battery.

6.3 LEDs on Battery

The LEDs can show the state of charge or malfunctions. The LEDs can glow or flash green or red.

The state of charge is indicated when the LEDs glow or flash green.

- ▶ If the LEDs glow or flash red: Troubleshooting,  18.
Malfunction in blower or battery.

7 Activating and Deactivating Bluetooth® Radio Interface

7.1 Activating the Bluetooth® Radio Interface

- ▶ If the battery has a Bluetooth® radio interface: Press and hold the pushbutton until the "BLUETOOTH®" LED next to the  symbol lights up blue for approximately 3 seconds. The Bluetooth® radio interface on the battery is activated.

7.2 Deactivating the Bluetooth® Radio Interface

- ▶ If the battery has a Bluetooth® radio interface: Press and hold the pushbutton until the "BLUETOOTH®" LED next to the  symbol lights up blue six times. The Bluetooth® radio interface on the battery is deactivated.

7.3 Reset battery to the factory setting via a Bluetooth® radio interface (AP 200.0 S, 300 S, 300.0 S, 500.0 S only)

Resetting the battery to the factory setting means that all user-specific data will be deleted.

- ▶ Press the pushbutton four (4) times in quick succession and keep it pressed on the fourth time until the "BLUETOOTH®" LED next to the  symbol flashes blue.
- ▶ Then release the pushbutton immediately.
- ▶ Connect the battery to the STIHL connected app and check whether all user-specific data has been deleted.

8 Assembling the Blower

8.1 Attaching and removing the nozzle

- ▶ Switch off the blower and remove the battery.

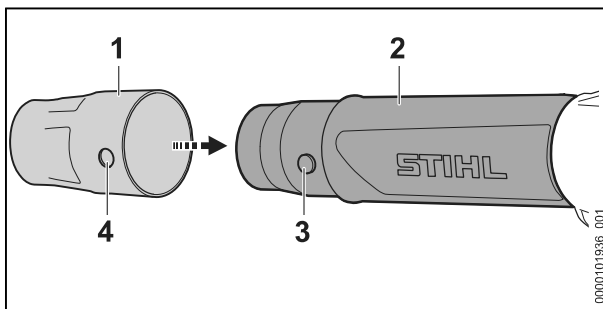

- ▶ Align the pin (3) and hole (4).
- ▶ Push the nozzle (1) onto the blower tube (4).
- ▶ Rotate nozzle (1) until it engages. The nozzle does not need to be removed again.

9 Removing and Fitting the Battery

9.1 Inserting the battery

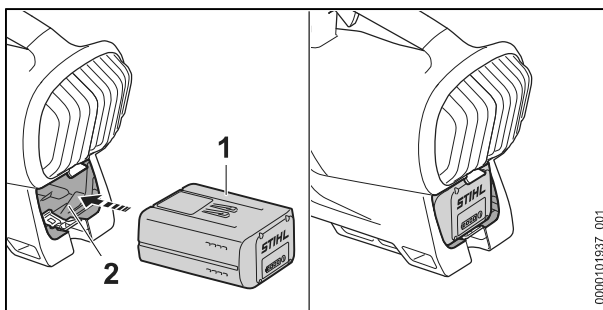

- ▶ Insert the battery (1) into the battery compartment (2) as far as it will go. The battery (1) engages with a click and is now locked.

9.2 Removing the battery

- ▶ Keep one hand in front of the battery compartment so that the battery (2) cannot fall out.

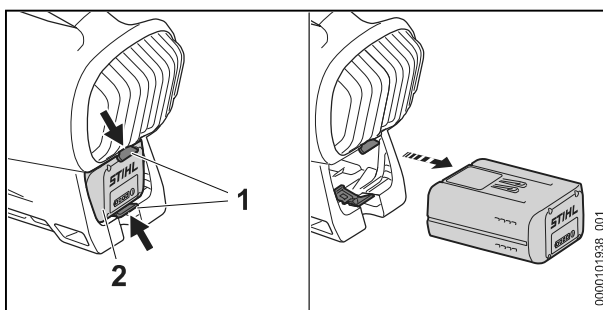

- ▶ Press both locking levers (1). The battery (2) is now unlocked and can be removed.

10 Switching the Blower On/Off

10.1 Switching on the blower

- ▶ Hold the blower by the control handle with one hand and wrap your thumb around the control handle.

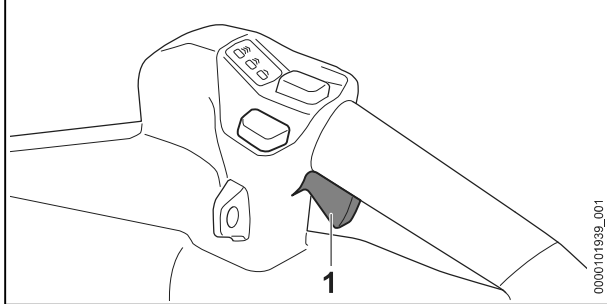

- ▶ Press the trigger (1) with your index finger and keep it pressed.
The blower accelerates and air flows out of the nozzle.

The further the trigger (1) is pressed, the more air flows out of the nozzle.

10.2 Switching Off

- ▶ Release the trigger.
No air flows from the nozzle.
- ▶ If air continues to flow from nozzle: Remove the battery and contact your STIHL servicing dealer.
Blower has a malfunction.

11 Testing the Blower and Battery

11.1 Checking the controls

Trigger

- ▶ Remove the battery.
- ▶ Press the trigger.
- ▶ If the trigger is stiff or does not spring back to its idle position: Do not use the blower and instead contact a STIHL authorized dealer.
The trigger is defective.

Switching on the blower

- ▶ Insert the battery.
- ▶ Press and hold the trigger.
Air flows out of the nozzle.
- ▶ If 3 LEDs on the battery flash red: Remove the battery and contact a STIHL authorized dealer.
There is an error in the blower.
- ▶ Release the trigger.
Air stops flowing out of the nozzle.

- ▶ If air continues to flow out of the nozzle:
Remove the battery and consult a STIHL servicing dealer.
The blower is defective.

11.2 Testing the Battery

- ▶ Press button on battery.
The LEDs glow or flash.
- ▶ If the LEDs do not glow or flash: Do not use the battery and contact your STIHL servicing dealer.
There is a malfunction in the battery.

12 Operating the Blower

12.1 Holding and controlling the Blower

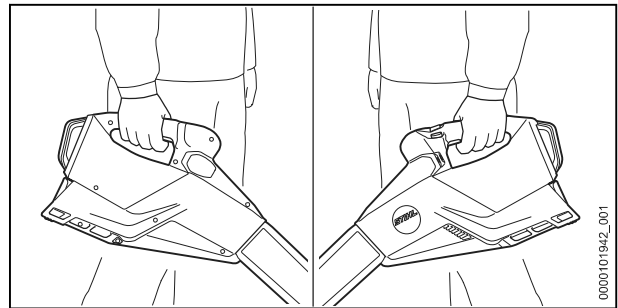

- ▶ Hold and control the blower with one hand on the control handle and wrap your thumb around the control handle.

12.2 Setting the Power Level

Depending on the application, you can set 3 power levels. The LEDs on the blower indicate the selected power level. The higher the power level, the greater the volume of air that flows from the nozzle.

The selected power level affects the battery's runtime. The lower the power level, the longer the battery runtime.

- ▶ Switch on the blower.
The LEDs on the blower light up to indicate the selected power level.

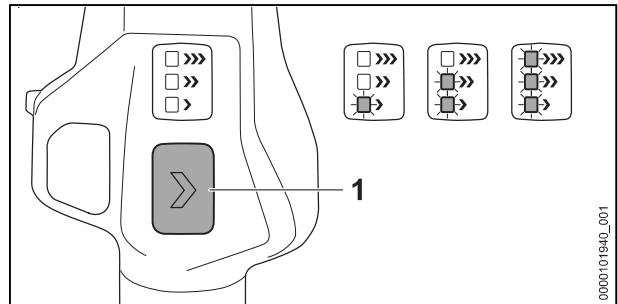

- ▶ Press the power setting button (1).
This selects the next power level. After the third performance level, it starts again with the first performance level.
- ▶ Press the power setting button (1) as many times as necessary to select the desired power level.

12.3 Activating and deactivating the power lock

The power lock can be activated independently of the selected power level. Any desired blowing force can be locked by using the power lock button.

- ▶ Switch on the blower.
- ▶ Set the power level.

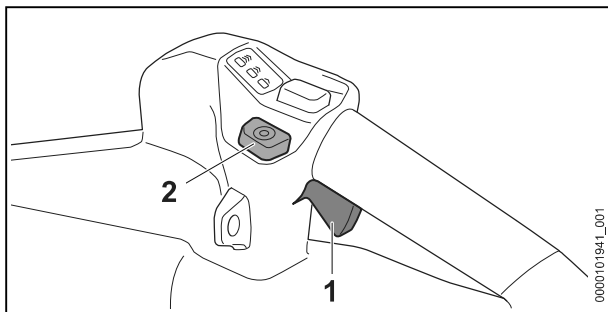

- ▶ Use trigger (1) to adjust blowing force.
- ▶ Press the power lock button (2).
The blowing force is locked. You can let go of the trigger.

Before shutting down: Deactivate power lock.

To deactivate the power lock, press the power lock button (2) again.

12.4 Activating the boost function

The boost function can be activated independently of the selected power level. The blower operates at maximum power when the boost function is activated.

The boost function affects the battery runtime. The longer the boost function is activated, the shorter the battery runtime.

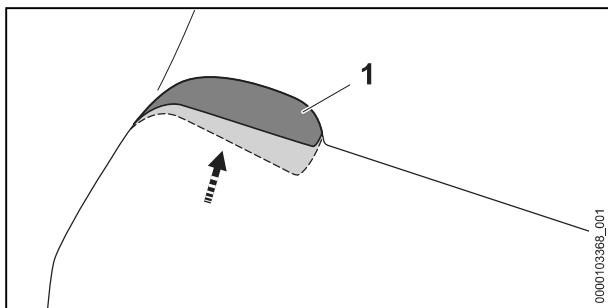

- ▶ Override the trigger (1) and hold it depressed.

The LEDs flash one after the other. The boost function is activated.

The boost function is deactivated when you release the trigger (1). The previously selected power level is reset.

12.5 Blowing

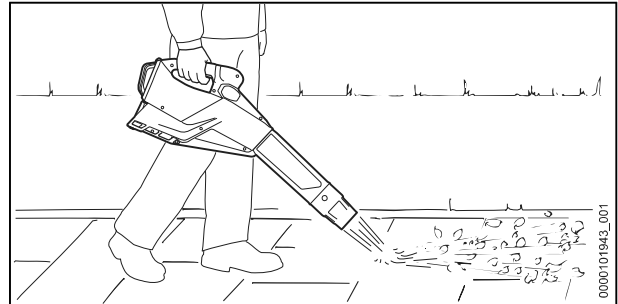

- ▶ Point the nozzle at the ground.
- ▶ Walk forward slowly and steadily.

During work breaks, place the blower on a dry surface.

For optimum performance, note the recommended temperature ranges, [19.4](#).

13 After Finishing Work

13.1 After Finishing Work

- ▶ Turn off the blower and remove the battery.
- ▶ If the blower is wet: Allow the blower to dry.
- ▶ If the battery is moist or wet: Allow the battery to dry, [19.4](#).
- ▶ Clean the blower.
- ▶ Clean the battery.

14 Transporting

14.1 Transporting the blower

- ▶ Switch off the blower and remove the battery.

Carrying the blower

- ▶ Carry blower by the control handle in one hand.

Transporting the blower in a vehicle

- ▶ Secure the blower so that it cannot topple over and cannot move.

14.2 Transporting the battery

- ▶ Turn off the blower and remove the battery.
- ▶ Check that the battery is in a safe condition.
- ▶ Pack the battery in packaging in such a way that it cannot move inside the packaging.
- ▶ Secure the packaging so that it cannot move.

The battery is subject to the Carriage of Dangerous Goods regulations. The battery is classified

as UN 3480 (lithium ion batteries) and has been tested pursuant to UN Manual Tests and Criteria Part III, Subsection 38.3.

The transport regulations can be found at www.stihl.com/safety-data-sheets.

15 Storing

15.1 Storing the blower

- ▶ Turn off the blower and remove the battery.
- ▶ The blower should be stored in such a way that the following conditions are fulfilled:
 - The blower cannot topple over and cannot move.
 - The blower must be out of the reach of children.
 - The blower must be clean and dry.

15.2 Storing the Battery

STIHL recommends keeping the battery in a charging state between 40% and 60 % (2 green LEDs lit).

- ▶ The battery should be stored in such a way that the following conditions are fulfilled:
 - The battery is out of the reach of children.
 - The battery is clean and dry.
 - The battery is in an enclosed space.
 - Battery is stored separately from the blower.
 - If the battery is stored in the charger, disconnect the mains plug and store the battery at a state of charge between 40% and 60% (2 lit green LEDs).
 - Do not store the battery outside of the specified temperature limits,  19.3.

NOTICE

- If the battery is not stored as described in this User Manual, the battery may become deeply discharged and irreparably damaged.
 - ▶ Charge a discharged battery before storing it. STIHL recommends keeping the battery state of charge between 40% and 60% (2 lit green LEDs).
 - ▶ Store the battery separately from the blower.

18 Troubleshooting

18.1 Troubleshooting the blower or battery

| Error | LEDs on the battery | Cause | Remedy |
|---|-----------------------|--|--|
| The blower does not start when switched on. | 1 LED flashing green. | The state of charge of the battery is too low. | ▶ Recharge the battery fully as described in the user manual for the STIHL AL 101, 301, 301-4, 501 chargers. |

16 Cleaning

16.1 Cleaning the blower

- ▶ Switch off the blower and remove the battery.
- ▶ Clean blower with a damp cloth.
- ▶ Clean vents with a paintbrush.
- ▶ Remove foreign objects from the battery compartment and clean the battery compartment with a damp cloth.
- ▶ Clean the electrical contacts in the battery compartment with a paintbrush or soft brush.
- ▶ Clean the shield with a paintbrush or soft brush.

16.2 Cleaning the Battery

- ▶ Clean the battery with a damp cloth.

17 Maintenance and Repairs

17.1 Servicing and Repairing the Blower



The blower cannot be serviced or repaired by the user.

- ▶ If your blower has a malfunction or is damaged or requires servicing: Contact your STIHL servicing dealer.

17.2 Servicing and Repairing the Battery

The battery requires no servicing and cannot be repaired.

- ▶ If the battery has a malfunction or is damaged: Replace the battery.

| Error | LEDs on the battery | Cause | Remedy |
|--|-----------------------------|---|--|
| | 1 LED lights up steady red. | The battery is too warm or too cold. | <ul style="list-style-type: none"> ▶ Remove the battery. ▶ Allow the battery to cool down or warm up. |
| | 3 LEDs flash red. | There is an error in the blower. | <ul style="list-style-type: none"> ▶ Remove the battery. ▶ Clean the electrical contacts in the battery compartment. ▶ Insert the battery. ▶ Switch on blower. ▶ If 3 LEDs continue to flash red: Do not use the blower and contact your STIHL dealer for assistance. |
| | 3 LEDs light up red. | The blower is too warm. | <ul style="list-style-type: none"> ▶ Remove the battery. ▶ Allow the blower to cool down. |
| | 4 LEDs flash red. | There is an error in the battery. | <ul style="list-style-type: none"> ▶ Remove battery and reinsert it. ▶ Switch on blower. ▶ If 4 LEDs continue to flash red: Do not use the battery and instead contact a STIHL authorized dealer for assistance. |
| | | There is a break in the electrical connection between the blower and the battery. | <ul style="list-style-type: none"> ▶ Remove the battery. ▶ Clean the electrical contacts in the battery compartment. ▶ Insert the battery. |
| | | The blower or the battery is damp. | <ul style="list-style-type: none"> ▶ Allow blower or battery to dry,  19.4. |
| The blower switches off while in operation. | 3 LEDs light up red. | The blower is too warm. | <ul style="list-style-type: none"> ▶ Remove the battery. ▶ Allow the blower to cool down. |
| | | There is an electrical error. | <ul style="list-style-type: none"> ▶ Remove battery and reinsert it. ▶ Switch on blower. |
| The blower operating time is too short. | | The battery is not fully charged. | <ul style="list-style-type: none"> ▶ Recharge the battery fully as described in the User Manual for the STIHL AL 101, 301, 301-4, 501 chargers. |
| | | The battery service life has been exceeded. | <ul style="list-style-type: none"> ▶ Replace battery. |
| The STIHL connected app is unable to find the battery with  . | | The Bluetooth® radio interface on the battery or mobile device is deactivated. | <ul style="list-style-type: none"> ▶ Activate the Bluetooth® radio interface on the battery or mobile device. |
| | | Excessive distance between the battery and the mobile device. | <ul style="list-style-type: none"> ▶ Reduce the distance,  19.2. ▶ If the STIHL connected app is still unable to find the battery: Contact a STIHL authorized dealer. |

18.2 Product Support and Assistance on Use

Product support and assistance on use are available from STIHL servicing dealers.

For contacts and other information, please visit <https://support.stihl.com> or www.stihl.com.

19 Specifications

19.1 STIHL blower BGA 250.0

– Permitted batteries:

- STIHL AP
- STIHL AR
- Blowing force: 26 N
- Maximum air velocity: 85 m/s
- Average air velocity: 71 m/s
- Air throughput: 1040 m³/h
- Weight without battery: 2.7 kg
- Degree of protection: IPX4 (protection against splash water from any direction)

For runtime, see www.stihl.com/battery-life.

19.2 STIHL AP Battery

- Battery technology: Lithium-ion
- Voltage: 36 V
- Capacity in Ah: see rating label
- Energy content in Wh: see rating label
- Weight in kg: See rating label
- Bluetooth® radio interface (only for batteries with - Data connection: Bluetooth® 5.1. The mobile device must be compatible with Bluetooth® Low Energy 5.0 and support Generic Access Profile (GAP).
- Frequency band: ISM band 2.4 GHz
- Maximum RF power transmitted: 1 mW
- Signal range: approx. 10 m. The signal strength depends on the ambient conditions and the mobile device. The signal range can vary greatly depending on local conditions and the receiver used. The range may be perceptibly reduced inside enclosed rooms and through metal barriers (such as walls, shelves or cases).
- Mobile device operating system requirements: Android or iOS (current version or higher)

The power output of the battery may vary depending on the battery product used.

19.3 Temperature limits



- The battery is not protected against all ambient conditions. If the battery is exposed to certain environmental conditions, it may catch fire or explode. This may result in serious injury to people and damage to property.
 - ▶ Do not charge the battery below - 20°C or above 50°C.
 - ▶ Do not use the blower or battery below - 20°C or above 50°C.
 - ▶ Do not store the blower or the battery below -20°C or above +70°C.

19.4 Recommended temperature ranges

For optimum performance of the blower and battery, observe the following temperature ranges:

- Charging: 5°C to 40°C
- Use: - 10 °C to + 40 °C
- Storage: - 20 °C to + 50 °C

If the battery is charged, used or stored outside the recommended temperature ranges, performance may be restricted.

If the battery is wet or moist, allow the battery to dry for at least 48 h between 15°C and 50°C and with less than 70% humidity. Higher humidity may extend the drying time.

19.5 Sound and vibration values

The K-value for the sound pressure level is 2 dB(A). The K value for the sound power level is 2 dB(A). The K value for the vibration level is 2 m/s².

STIHL recommends wearing hearing protection.

- Sound pressure level L_{pA} measured in accordance with IEC 62841-4-6: 84 dB(A).
- Sound power level L_{WA} measured in accordance with IEC 62841-4-6: 92 dB(A).
- Vibration value a_{hv} measured according to IEC 62841-4-6: Control handle: 0.9 m/s².

The sound and vibration values indicated were measured according to a standardized test method and can be used as a basis for comparing electric power tools. The actual sound and vibration levels may vary from the values indicated, depending on the type of application and the accessories used. The sound and vibration levels indicated can be used for an initial estimate of the sound and vibration load. The actual sound and vibration stress has to be estimated. The times can be taken into account in the estimate when the electric power tool is switched off and also when it is switched on but running without any load.

For information on compliance with the Physical Agents (Vibration) Directive 2002/44/EC, see www.stihl.com/vib.

19.6 REACH

REACH is an EC regulation and stands for the Registration, Evaluation, Authorisation and Restriction of Chemical substances.

For information on compliance with the REACH regulation see www.stihl.com/reach.

20 Spare Parts and Accessories

20.1 Spare parts and accessories

STIHL  These symbols indicate original STIHL spare parts and original STIHL accessories.

STIHL recommends the use of original STIHL spare parts and accessories.

Despite ongoing market observation, STIHL is unable to judge the reliability, safety and suitability of other manufacturers' spare parts and accessories; accordingly, STIHL cannot warrant for the use of those parts.

Original STIHL spare parts and original STIHL accessories are available from STIHL dealers.

21 Disposal

21.1 Disposing of the Blower and Battery

Contact the local authorities or your STIHL dealer for information on disposal.

Improper disposal can be harmful to health and pollute the environment.

- ▶ Take STIHL products including packaging to a suitable collection point for recycling in accordance with local regulations.
- ▶ Do not dispose with domestic waste.

22 EC Declaration of Conformity

22.1 STIHL BGA 250.0 blower

ANDREAS STIHL AG & Co. KG
Badstraße 115
D-71336 Waiblingen

Germany

declares under our sole responsibility that

- Category: Battery blower
- Manufacturer's brand: STIHL
- Model: BGA 250.0
- Serial identification number: BA06

conforms to the relevant provisions of Directives 2011/65/EU, 2006/42/EC, 2014/30/EU and 2000/14/EC and has been developed and manufactured in compliance with the following standards in the versions valid on the date of production: EN 55014-1, EN 55014-2 and EN 62841-1, taking account of standards IEC 62841-4-6 and prEN 62841-4-6.

The measured and guaranteed equivalent sound power level has been determined in accordance with Directive 2000/14/EC, Annex V.

- Measured sound power level: 92 dB(A)
- Guaranteed sound power level: 94 dB(A)

The technical documents are stored at ANDREAS STIHL AG & Co. KG Produktzulassung.

The year of construction, the country of manufacture and the machine number are shown on the blower.

Waiblingen, 01. 02. 2024

ANDREAS STIHL AG & Co. KG

pp 

Robert Olma, Vice President, Regulatory Affairs & Global Governmental Relations

23 UKCA Declaration of Conformity

23.1 STIHL BGA 250.0 blower

**UK
CA**

ANDREAS STIHL AG & Co. KG
Badstraße 115
D-71336 Waiblingen

Germany

declares under our sole responsibility that

- Category: Battery blower
- Manufacturer's brand: STIHL
- Type: BGA 250.0
- Serial identification number: BA06

complies with the relevant provisions of the UK regulations The Restriction of the Use of Certain Hazardous Substances in Electrical and Electronic Equipment Regulations 2012, Supply of Machinery (Safety) Regulations 2008, Electromagnetic Compatibility Regulations 2016 and Noise Emission in the Environment by Equipment for use Outdoors Regulations 2001 and has been developed and manufactured in accordance with the versions of the following standards valid on the date of manufacture: EN 55014-1, EN 55014-2 and EN 62841-1, taking into account standards IEC 62841-4-6 and prEN 62841-4-6.

The measured and guaranteed sound power levels have been determined in accordance with UK regulations Noise Emission in the Environment by Equipment for use Outdoors Regulations 2001, Schedule 8.

- Measured sound power level: 92 dB(A)
- Guaranteed sound power level: 94 dB(A)

The technical documentation is stored at ANDREAS STIHL AG & Co. KG.

The year of construction, the country of manufacture and the machine number are shown on the blower.

Waiblingen, 2024. 0201

ANDREAS STIHL AG & Co. KG

pp 

Robert Olma, Vice President, Regulatory Affairs
& Global Governmental Relations

24 Addresses

www.stihl.com

25 General Power Tool Safety Warnings

25.1 Introduction

This chapter reproduces the pre-formulated, general safety precautions specified in the IEC 62841 standard for hand-held motor-operated electric tools.

STIHL is obliged to publish these texts.

The safety precautions and warnings on avoiding an electric shock given under "Electrical Safety" do not apply to STIHL cordless products.



WARNING

- **Read all safety warnings, instructions, illustrations and specifications provided with this power tool.** Failure to follow all instructions listed below may result in electric shock, fire and/or serious injury. **Save all warnings and instructions for future reference.**

The term "electric power tool" in the safety warnings refers to mains-operated (corded) power tools or battery-operated (cordless) power tools.

25.2 Work area safety

- a) **Keep work area clean and well lit.** Cluttered or dark areas invite accidents.
- b) **Do not operate power tools in explosive atmospheres, such as in the presence of flammable liquids, gases or dust.** Power tools create sparks which may ignite the dust or fumes.
- c) **Keep children and bystanders away while operating a power tool.** Distractions can cause you to lose control.

25.3 Electrical safety

- a) **Power tool plugs must match the outlet. Never modify the plug in any way. Do not use any adapter plugs with earthed (grounded) power tools.** Unmodified plugs and matching outlets will reduce risk of electric shock.
- b) **Avoid body contact with earthed or grounded surfaces, such as pipes, radiators, ranges and refrigerators.** There is an increased risk of electric shock if your body is earthed or grounded.
- c) **Do not expose power tools to rain or wet conditions.** Water entering a power tool will increase the risk of electric shock.
- d) **Do not abuse the cord. Never use the cord for carrying, pulling or unplugging the power tool. Keep cord away from heat, oil, sharp edges or moving parts.** Damaged or entangled cords increase the risk of electric shock.
- e) **When operating a power tool outdoors, use an extension cord suitable for outdoor use.** Use of a cord suitable for outdoor use reduces the risk of electric shock.
- f) **If operating a power tool in a damp location is unavoidable, use a residual current device (RCD) protected supply.** Use of an RCD reduces the risk of electric shock.

25.4 Personal safety

- a) **Stay alert, watch what you are doing and use common sense when operating a power tool. Do not use a power tool while you are tired or under the influence of drugs, alcohol or medication.** A moment of inattention while operating power tools may result in serious personal injury.
- b) **Use personal protective equipment. Always wear eye protection.** Protective equipment such as a dust mask, non-skid safety shoes, hard hat or hearing protection used for appropriate conditions will reduce personal injuries.
- c) **Prevent unintentional starting. Ensure the switch is in the off-position before connecting to power source and/or battery pack, picking up or carrying the tool.** Carrying power tools with your finger on the switch or energising power tools that have the switch on invites accidents.
- d) **Remove any adjusting key or wrench before turning the power tool on.** A wrench or a key

left attached to a rotating part of the power tool may result in personal injury.

- e) **Do not overreach. Keep proper footing and balance at all times.** This enables better control of the power tool in unexpected situations.
- f) **Dress properly. Do not wear loose clothing or jewellery. Keep your hair and clothing away from moving parts.** Loose clothes, jewellery or long hair can be caught in moving parts.
- g) **If devices are provided for the connection of dust extraction and collection facilities, ensure these are connected and properly used.** Use of dust collection can reduce dust-related hazards.
- h) **Do not let familiarity gained from frequent use of tools allow you to become complacent and ignore tool safety principles.** A careless action can cause severe injury within a fraction of a second.

25.5 Power tool use and care

- a) **Do not force the power tool. Use the correct power tool for your application.** The correct power tool will do the job better and safer at the rate for which it was designed.
- b) **Do not use the power tool if the switch does not turn it on and off.** Any power tool that cannot be controlled with the switch is dangerous and must be repaired.
- c) **Disconnect the plug from the power source and/or remove the battery pack, if detachable, from the power tool before making any adjustments, changing accessories, or storing power tools.** Such preventive safety measures reduce the risk of starting the power tool accidentally.
- d) **Store idle power tools out of the reach of children and do not allow persons unfamiliar with the power tool or these instructions to operate the power tool.** Power tools are dangerous in the hands of untrained users.
- e) **Maintain power tools and accessories. Check for misalignment or binding of moving parts, breakage of parts and any other condition that may affect the power tool's operation. If damaged, have the power tool repaired before use.** Many accidents are caused by poorly maintained power tools.
- f) **Keep cutting tools sharp and clean.** Properly maintained cutting tools with sharp cutting edges are less likely to bind and are easier to control.

- g) **Use the power tool, accessories and tool bits etc. in accordance with these instructions, taking into account the working conditions and the work to be performed.** Use of the power tool for operations different from those intended could result in a hazardous situation.
- h) **Keep handles and grasping surfaces dry, clean and free from oil and grease.** Slippery handles and grasping surfaces do not allow for safe handling and control of the tool in unexpected situations.

25.6 Battery tool use and care

- a) **Recharge only with the charger specified by the manufacturer.** A charger that is suitable for one type of battery pack may create a risk of fire when used with another battery pack.
- b) **Use power tools only with specifically designated battery packs.** Use of any other battery packs may create a risk of injury and fire.
- c) **When battery pack is not in use, keep it away from other metal objects, like paper clips, coins, keys, nails, screws or other small metal objects, that can make a connection from one terminal to another.** Shorting the battery terminals together may cause burns or a fire.
- d) **Under abusive conditions, liquid may be ejected from the battery; avoid contact. If contact accidentally occurs, flush with water. If liquid contacts eyes, additionally seek medical help.** Liquid ejected from the battery may cause irritation or burns.
- e) **Do not use a battery pack or tool that is damaged or modified.** Damaged or modified batteries may exhibit unpredictable behaviour resulting in fire, explosion or risk of injury.
- f) **Do not expose a battery pack or tool to fire or excessive temperature.** Exposure to fire or temperature above 130 °C may cause explosion.
- g) **Follow all charging instructions and do not charge the battery pack or tool outside the temperature range specified in the instructions.** Charging improperly or at temperatures outside the specified range may damage the battery and increase the risk of fire.

25.7 Service

- a) **Have your power tool serviced by a qualified repair person using only identical replace-**

ment parts. This will ensure that the safety of the power tool is maintained.

- b) **Never service damaged battery packs.** Service of battery packs should only be performed by the manufacturer or authorized service providers.

25.8 Safety Information for Blowers

- a) **Do not use your blower in bad weather, especially during thunderstorms.** This reduces the risk of being struck by lightning.
- b) **Wear safety glasses and hearing protection.** Wearing suitable personal protective equipment will reduce the risk of injury.
- c) **Always wear non-slip, protective shoes when operating the blower. Never work barefoot or with open sandals.** This will reduce the risk of a foot injury.
- d) **Do not wear loose fitting clothing or items such as scarves, cords, chains, ribbons, etc., that could be sucked into the air inlet vent. Tie up your hair or cover it to prevent it from being sucked into the air inlet vent.** The sucking of any of these items into the air inlet vent may increase the risk of injury.
- e) **Keep your blower at a distance from other people during operation.** Deflected waste may increase the risk of injury.
- f) **Never aim the blower nozzle in the direction of people, animals or windows. Operate the device with particular attention when clearing waste away from fixed objects, such as trees, cars or walls, from which waste may be deflected.** Deflected parts may increase the risk of injury.
- g) **Do not use the blower to clear burning or smoking waste, such as cigarettes, matches or ash.** These sources of ignition may increase the risk of fire.
- h) **Do not touch the fan while it is still turning. Switch off the blower and wait until the fan stands still before removing a part that provides access to the fan.** This will reduce the risk of injury due to moving parts.
- i) **Before removing trapped cuttings or servicing the blower, ensure that the switch is turned off.** An unexpected startup of the blower while removing trapped cuttings or during servicing may increase the risk of injury.

Table des matières

| | | |
|----|---|----|
| 1 | Préface..... | 36 |
| 2 | Informations concernant la présente Notice d'emploi..... | 37 |
| 3 | Vue d'ensemble..... | 37 |
| 4 | Prescriptions de sécurité..... | 38 |
| 5 | Préparatifs avant l'utilisation du souffleur.. | 43 |
| 6 | Recharge de la batterie et DEL..... | 44 |
| 7 | Activation et désactivation de l'interface radio Bluetooth®..... | 44 |
| 8 | Assemblage du souffleur..... | 45 |
| 9 | Introduction et extraction de la batterie.... | 45 |
| 10 | Mise en marche et arrêt du souffleur..... | 45 |
| 11 | Contrôle du souffleur et de la batterie..... | 46 |
| 12 | Travail avec le souffleur..... | 46 |
| 13 | Après le travail..... | 47 |
| 14 | Transport..... | 47 |
| 15 | Rangement..... | 48 |
| 16 | Nettoyage..... | 48 |
| 17 | Maintenance et réparation..... | 48 |
| 18 | Dépannage..... | 49 |
| 19 | Caractéristiques techniques..... | 50 |
| 20 | Pièces de rechange et accessoires..... | 51 |
| 21 | Mise au rebut..... | 51 |
| 22 | Déclaration de conformité UE..... | 51 |
| 23 | Déclaration de conformité UKCA..... | 52 |
| 24 | Adresses..... | 52 |
| 25 | Indications générales de sécurité pour outils électroportatifs..... | 53 |

1 Préface

Chère cliente, cher client,

Nous vous remercions d'avoir choisi un produit STIHL. Dans le développement et la fabrication de nos produits, nous mettons tout en œuvre pour garantir une excellente qualité répondant aux besoins de nos clients. Nos produits se distinguent par une grande fiabilité, même en cas de sollicitations extrêmes.

STIHL garantit également la plus haute qualité au niveau du service après-vente. Nos revendeurs spécialisés fournissent des conseils compétents, aident nos clients à se familiariser avec nos produits et assurent une assistance technique complète.

STIHL se déclare résolument en faveur d'un développement durable et d'une gestion responsable de la nature. La présente Notice d'emploi vous aidera à utiliser votre produit STIHL en toute sécurité et dans le respect de l'environnement, pendant toute sa longue durée de vie.